

WN 620  
81RA  
c.2

C.2

# *Environmental Health Criteria 16*

## Radiofrequency and Microwaves



Published under the joint  
sponsorship of the  
United Nations  
Environment Programme,  
the World Health Organization  
and the International Radiation  
Protection Association



WORLD HEALTH ORGANIZATION GENEVA 1981

TC 12

WN 620

81 Ra

C. 2

Other titles available in the ENVIRONMENTAL HEALTH CRITERIA series include:

1. Mercury
2. Polychlorinated Biphenyls and Terphenyls
3. Lead
4. Oxides of Nitrogen
5. Nitrates, Nitrites and N-Nitroso Compounds
6. Principles and Methods for Evaluating the Toxicity of Chemicals, Part 1
7. Photochemical Oxidants
8. Sulfur Oxides and Suspended Particulate Matter
9. DDT and its Derivatives
10. Carbon Disulfide
11. Mycotoxins
12. Noise
13. Carbon Monoxide
14. Ultraviolet Radiation
15. Tin and Organotin Compounds

BON  
14260

This report contains the collective views of an international group of experts and does not necessarily represent the decisions or the stated policy of either the World Health Organization, the United Nations Environment Programme, or the International Radiation Protection Association.

## Environmental Health Criteria 16

# RADIOFREQUENCY AND MICROWAVES

Published under the joint sponsorship of  
the United Nations Environment Programme,  
the World Health Organization and the  
International Radiation Protection  
Association



World Health Organization  
Geneva, 1981

ISBN 92 4 154076 1

© World Health Organization 1981

Publications of the World Health Organization enjoy copyright protection in accordance with the provisions of Protocol 2 of the Universal Copyright Convention. For rights of reproduction or translation of WHO publications, in part or *in toto*, application should be made to the Office of Publications, World Health Organization, Geneva, Switzerland. The World Health Organization welcomes such applications.

The designations employed and the presentation of the material in this publication do not imply the expression of any opinion whatsoever on the part of the Secretariat of the World Health Organization concerning the legal status of any country, territory, city or area or of its authorities, or concerning the delimitation of its frontiers or boundaries.

The mention of specific companies or of certain manufacturers' products does not imply that they are endorsed or recommended by the World Health Organization in preference to others of a similar nature that are not mentioned. Errors and omissions excepted, the names of proprietary products are distinguished by initial capital letters.

PRINTED IN FINLAND

80/4729 — VAMMALA — 7000

# CONTENTS

---

ENVIRONMENTAL HEALTH CRITERIA FOR RADIOFREQUENCY AND MICROWAVES .....	8
1. SUMMARY AND RECOMMENDATIONS FOR FURTHER STUDIES .....	10
1.1 Summary .....	10
1.1.1 Physical characteristics in relation to biological effects	10
1.1.2 Sources and control of exposure .....	11
1.1.3 Biological effects in experimental animals .....	12
1.1.4 Power density ranges in relation to health effects ....	13
1.1.5 Exposure effects in man .....	13
1.1.6 Health risk evaluation as a basis for exposure limits ..	14
1.2 Recommendations for further studies, exposure limits, and protective measures .....	14
1.2.1 General recommendations .....	14
1.2.2 Measurement techniques .....	15
1.2.3 Safety procedures .....	15
1.2.4 Biological investigations .....	16
1.2.5 Epidemiological investigations .....	16
1.2.6 Exposure limits and emission standards .....	17
1.2.6.1 Occupational exposure limits .....	17
1.2.6.2 Exposure limits for the general population ....	17
1.2.6.3 Emission standards .....	17
1.2.6.4 Implementation of standards .....	17
1.2.6.5 Other protective measures .....	18
1.2.6.6 Studies related to the establishment of limits	18
2. MAGNITUDE OF EXPOSURE TO MICROWAVE AND RF RADIATION AND SOURCES OF CONCERN .....	18
3. PROPERTIES OF MICROWAVE AND RADIOFREQUENCY (RF) RADIATION .....	19
3.1 Units of radiation .....	21
3.2 Other physical considerations .....	22
4. SOURCES AND CONDITIONS OF EXPOSURE .....	23
4.1 Natural background sources .....	23
4.2 Man-made sources .....	25
4.2.1 Deliberate emitters .....	25
4.2.2 Sources of unintentional radiation .....	32
4.3 Estimating exposure levels .....	35
4.3.1 Far-field exposure .....	35
4.3.2 Near-field exposure .....	35
4.4 Facilities for controlled exposure .....	36
4.4.1 Free space standard field method .....	37
4.4.2 Guided wave methods .....	38
4.4.3 Standard probe method .....	39
5. MEASURING INSTRUMENTS .....	40
5.1 General principles .....	40
5.2 Types of instruments in common use .....	41

5.2.1 Diode rectifier .....	41
5.2.2 Bolometer .....	41
5.2.3 Thermocouple .....	42
6. MICROWAVE AND RF ENERGY ABSORPTION IN BIOLOGICAL SYSTEMS .....	42
6.1 Methods of computation .....	43
6.2 Experimental methods .....	43
6.3 Energy absorption .....	44
6.4 Molecular absorption .....	48
7. BIOLOGICAL EFFECTS IN EXPERIMENTAL ANIMALS .....	49
7.1 Hyperthermia and gross thermal effects .....	50
7.2 Effects on the eye .....	54
7.3 Neuroendocrine effects .....	58
7.4 Nervous system and behavioural effects .....	62
7.5 Effects on the blood forming and immunocompetent cell systems .....	70
7.6 Genetic and other effects in cell systems .....	73
7.7 Effects on reproduction and development .....	76
8. HEALTH EFFECTS IN MAN .....	79
8.1 Effects of occupational exposure .....	80
8.1.1 Effects on the eyes .....	82
8.1.2 Effects on reproduction and genetic effects .....	82
8.1.3 Cardiovascular effects .....	82
8.2 Medical exposure .....	83
9. RATIONALES FOR MICROWAVE AND RF RADIATION PROTECTION STANDARDS .....	83
9.1 Principles .....	83
9.2 Group 1 standards .....	84
9.3 Group 2 standards .....	85
9.4 Group 3 standards .....	90
9.5 RF radiation standards (100 kHz to 300 MHz) .....	93
10. SAFETY PROCEDURES FOR OCCUPATIONALLY EXPOSED PERSONNEL .....	102
10.1 Procedures for reducing occupational exposure .....	102
11. ASSESSMENT OF DATA ON BIOLOGICAL EFFECTS AND RECOMMENDED EXPOSURE LIMITS .....	104
REFERENCES .....	106
GLOSSARY .....	126
ANNEX .....	133

## **NOTE TO READERS OF THE CRITERIA DOCUMENTS**

---

While every effort has been made to present information in the criteria documents as accurately as possible without unduly delaying their publication, mistakes might have occurred and are likely to occur in the future. In the interest of all users of the environmental health criteria documents, readers are kindly requested to communicate any errors found to the Division of Environmental Health, World Health Organization, Geneva, Switzerland, in order that they may be included in corrigenda which will appear in subsequent volumes.

In addition, experts in any particular field dealt with in the criteria documents are kindly requested to make available to the WHO Secretariat any important published information that may have inadvertently been omitted and which may change the evaluation of health risks from exposure to the environmental agent under examination, so that the information may be considered in the event of updating and re-evaluation of the conclusions contained in the criteria documents.

# WHO/IRPA TASK GROUP ON ENVIRONMENTAL HEALTH CRITERIA FOR RADIOFREQUENCY AND MICROWAVES

---

## *Members*

- Dr V. Akimenko, A. N. Marzeev Institute of General and Communal Hygiene, Kiev, USSR
- Professor P. Czernski, National Research Institute of Mother and Child, Warsaw, Poland (*Rapporteur*)<sup>a</sup>
- Mme A. Duchêne, Département de Protection, Centre d'Etudes nucléaires, Fontenay-aux-Roses, France <sup>a</sup>
- Dr M. Faber, Finsen Institute, Finsen Laboratory, Copenhagen, Denmark <sup>a</sup>
- Professor M. Grandolfo, Radiation Laboratory, Higher Institute of Health, Rome, Italy
- Mr F. Harlen, National Radiological Protection Board, Harwell, England
- Dr H. Jammet, Département de Protection, Centre d'Etudes nucléaires, Fontenay-aux-Roses, France <sup>a</sup>
- Dr J. Kupfer, Central Institute for Occupational Medicine of the GDR, Berlin, German Democratic Republic (*Vice-Chairman*)
- Dr M. Repacholi, Health Protection Branch, Department of National Health and Welfare, Ottawa, Canada <sup>a</sup>
- Dr B. Servantie, E.A.S.S.M. — Centre d'Etudes et de Recherche de Biophysologie, Toulon Naval, France
- Dr M. Shore, Bureau of Radiological Health, Food and Drug Administration, Department of Health, Education and Welfare, Rockville, MD, USA (*Chairman*)

## *Representatives of other Organizations*

- Mr H. Pouliquen, International Telecommunications Union, Geneva, Switzerland
- Dr G. Verfaillie, Commission of European Communities, Brussels, Belgium

## *Secretariat*

- Mr S. Fluss, Health and Biomedical Information Programme, WHO, Geneva, Switzerland
- Dr E. Komarov, Environmental Health Criteria and Standards, Division of Environmental Health, WHO, Geneva, Switzerland (*Secretary*)

---

<sup>a</sup> From the Committee on Non-Ionizing Radiation of the International Radiation Protection Association



**THE INTERNATIONAL SYSTEM OF UNITS (SI) COMMONLY USED IN ELECTROMAGNETICS**

Name of Dimension of Quantity	Symbol for quantity	SI unit and symbol
Admittance	Y	siemens (S)
Area, surface	S	square metre (m <sup>2</sup> )
Attenuation	A	1 (Non-SI unit is the dB)
Attenuation coefficient	$\alpha$	reciprocal metre (1/m)
Capacitance	C	farad (F)
Charge	Q	coulomb (C)
Charge, volume density of	$\rho$	coulomb per cubic metre (C/m <sup>3</sup> )
Conductance, electric	G	siemens (S)
Conductivity	$\sigma$	siemens per metre (S/m)
Current	I	ampere (A)
Current density	J	ampere per square metre (A/m <sup>2</sup> )
Dielectric polarization	P	coulomb per square metre (C/m <sup>2</sup> )
Dipole moment (electric)	$(P = D - \epsilon_0 E)$	coulomb · metre (C · m)
Dipole moment (magnetic)	$p$	weber metre (Wb · m)
Electric field strength	$i$	volt per metre (V/m)
Electric flux	K	coulomb (C)
Electric flux density	D	coulomb per square metre (C/m <sup>2</sup> )
Electric polarization	$\phi$	coulomb per square metre (C/m <sup>2</sup> )
Electric potential	$D_t$	volt (V)
Electric susceptibility	V	(see glossary)
Energy or work	$\chi_e$	joule (J)
Energy density	$(\chi_e = \epsilon_r - 1)$	joule per cubic metre (J/m <sup>3</sup> )
Frequency	E	hertz (Hz)
Impedance	w	ohm ( $\Omega$ )
Impedance, characteristic	f	ohm ( $\Omega$ )
Inductance, mutual	Z	henry (H)
Length	$Z_0$	metre (m)
Magnetic field strength	M	ampere per metre (A/m)
Magnetic flux	I	weber (Wb)
Magnetic flux density	H	tesla (T)
Magnetic polarization	$\Phi$	tesla (T)
Permeability	B	henry per metre (H/m)
Relative permeability	$B_t$	(see glossary)
Permittivity	$\mu$	farad per metre (F/m)
Phase coefficient	$(\mu_r = \mu/\mu_0)$	radian per metre (rad/m)
Power	$\epsilon$	watt (W)
Power gain	$\beta$	1 (Non-SI unit is the dB)
Poynting vector	P	watt per square metre (W/m <sup>2</sup> )
Propagation coefficient	G	Units for $\alpha$ and $\beta$ given separately
Radiant intensity	$(G = 10 \log (P_2/P_1))$	watt per steradian (W/sr)
Reactance	S	ohm ( $\Omega$ )
Wavelength	$\gamma$	metre (m)
	$(\gamma = \alpha + j\beta)$ where $\alpha$ = attenuation coefficient and $\beta$ = phase coefficient	

<sup>a</sup> The SI units for non-ionizing radiation have not been completely developed. Terms used in the text but not defined in this table can be found in the glossary at the end of the document.

## ENVIRONMENTAL HEALTH CRITERIA FOR RADIOFREQUENCY AND MICROWAVES

---

A Joint WHO/IRPA Task Group on Environmental Health Criteria for Radiofrequency and Microwaves met in Geneva from 18—22 December 1978. Dr B. H. Dieterich, Director, Division of Environmental Health, opened the meeting on behalf of the Director-General. The Task Group reviewed and revised the draft criteria document, made an evaluation of the health risks of exposure to radiofrequency and microwaves, and considered rationales for the development of exposure limits.

In November 1971, the WHO Regional Office for Europe convened a Working Group meeting in The Hague which recommended, *inter alia*, that the protection of man from microwave radiation hazards should be considered a priority activity in the field of non-ionizing radiation protection. To implement these recommendations, the Regional Office decided to prepare the manual on "Non-Ionizing Radiation Protection", which will include a chapter on microwave radiation (WHO, 1981).

In 1973, a symposium, sponsored by WHO and the Governments of Poland and the USA, was held in Warsaw, on the biological effects and health hazards of microwave radiation. This symposium provided one of the first opportunities for an international exchange of quite diverse opinions on the effects of microwaves. Recommendations adopted by the symposium included the promotion and coordination, at an international level, of research on the biological effects of microwaves, and the development of a non-ionizing programme by an international agency (Czerski et al., 1974a).

The International Radiation Protection Association (IRPA) became responsible for these activities by forming a Working Group on Non-Ionizing Radiation at its meeting in Washington, DC, in 1974. This Working Group later became the International Non-Ionizing Radiation Committee (IRPA/INIRC) at the IRPA meeting in Paris in 1977 (IRPA, 1977).

Two WHO Collaborating Centres, the National Research Institute of Mother and Child, Warsaw (for Biological Effects of Non-Ionizing Radiation) and the Bureau of Radiological Health, Rockville (for the Standardization of Non-Ionizing Radiation) cooperated with the IRPA/INIRC in initiating the preparation of the criteria document. The final draft was prepared as a result of several working group meetings, taking into account comments received from the national focal points for the WHO Environmental Health Criteria Programme

in Australia, Canada, Japan, Netherlands, New Zealand, Poland, Sweden, the United Kingdom, and the USA as well as from the United Nations Environment Programme, the United Nations Industrial Development Organization, the International Labour Organisation, the Food and Agriculture Organization of the United Nations, the United Nations Educational, Scientific and Cultural Organization, and the International Atomic Energy Agency. The collaboration of these national institutions and international organizations is gratefully acknowledged. Without their assistance this document could not have been completed. In particular, the Secretariat wishes to thank Professor P. Czernski, Mrs A. Duchêne, Mr F. Harlen, Dr M. Repacholi, and Dr M. Shore for their help in the final scientific editing of the document.

The document is based primarily on original publications listed in the reference section. Additional information was obtained from a number of general reviews, monographs and proceedings of symposia including: Gordon, 1966; Presman, 1968; Petrov, ed., 1970; Silverman et al., ed., 1970; Marha et al., 1971; Michaelson, 1977; Minin, 1974; Dumanski et al., 1975; Tyler, ed., 1975; Baranski & Czernski, 1976; Glaser & Brown, 1976; Glaser et al., 1976, 1977; IVA Committee, 1976; Johnson et al., 1976; Johnson & Shore, ed., 1977; Justesen & Guy, 1977; Hazzard, ed., 1977; Serdjuk, 1977; Taylor & Cheung, ed., 1977; National Health and Welfare, Canada, 1977, 1978; Durney et al., 1978.

Modern advances in science and technology change man's environment, introducing new factors which besides their intended beneficial uses may also have untoward side effects. Both the general public and health authorities are aware of the dangers of pollution by chemicals, ionizing radiation, and noise, and of the need to take appropriate steps for effective control. The increasing use of electrical and electronic devices, including the rapid growth of telecommunication systems (e.g., satellite systems), radiobroadcasting, television transmitters, and radar installations has increased the possibility of human exposure to electromagnetic energy and, at the same time, concern about possible health effects.

This document provides information on the physical aspects of electromagnetic fields and radiowaves in the frequency range of 100 kHz—300 GHz, which has been arbitrarily subdivided according to the traditional approach into microwaves (300 MHz to 300 GHz) and radiofrequencies (100 kHz to 300 MHz). A brief survey of man-made sources is presented. It is known that electromagnetic energy in this frequency range interacts with biological systems and a summary of knowledge on biological effects and health aspects has been included in the document. In a few countries, concern about occupational and public health aspects has led to the development of radiation protection guides and the establishment of exposure

limits. Several countries are considering the introduction of recommendations or legislation concerned with protection against the untoward effects of non-ionizing energy in this frequency range. In others, the tendency is to revise existing standards and to adopt less divergent exposure limits. It is hoped that this criteria document may provide useful information for the development of national protection measures against non-ionizing radiation.

Details of the WHO Environmental Health Criteria Programme, including some of the terms frequently used in the documents, can be found in the introduction to the environmental health criteria document on mercury (Environmental Health Criteria 1 — Mercury, World Health Organization, Geneva, 1976), now available as a reprint.

## **1. SUMMARY AND RECOMMENDATIONS FOR FURTHER STUDIES**

### **1.1 Summary**

#### **1.1.1 Physical characteristics in relation to biological effects**

Microwave and radiofrequency (RF) radiation constitute part of the whole electromagnetic spectrum. This document is concerned with frequencies lying between  $10^5$  and  $3 \times 10^{11}$  Hz (100 kHz and 300 GHz). The term radiofrequency refers to the range 100 kHz—300 MHz (3 km to 1 m wavelength in air) and microwaves to the frequency range of 300 MHz—300 GHz (1 m to 1 mm wavelength in air).

Exposure conditions in the microwave range are usually described in terms of "power density" and are reported in most studies in watts per square metre, or milliwatts or microwatts per square centimetre ( $\text{W}/\text{m}^2$ ,  $\text{mW}/\text{cm}^2$ ,  $\mu\text{W}/\text{cm}^2$ ). However, close to microwave and RF sources with longer wavelengths, the values of both the electric (V/m) and magnetic (A/m) field strengths provide a more appropriate description of the radiation. Exposure conditions can be altered considerably by the presence of objects, the degree of perturbation depending on their size, shape, orientation in the field, and electrical properties. Very complex field distributions can

occur, both inside and outside biological systems exposed to microwaves and RF. Refraction of the radiation within these systems can focus the transmitted radiation resulting in markedly nonuniform fields and energy deposition. Different energy absorption rates may result in thermal gradients causing biological effects that may be generated locally, difficult to predict, and perhaps unique.

When electromagnetic radiation passes from one medium to another, it can be reflected, refracted, transmitted, or absorbed, depending on the biological system and the frequency of the radiation. Absorbed microwave and RF energy can be converted to other forms of energy and cause interference with the functioning of the living system. Most of this energy is converted into heat. However, not all microwave and RF radiation effects can be explained in terms of the biophysical mechanisms of energy absorption and conversion to heat. It has been demonstrated both theoretically and experimentally that other types of energy conversion are possible. Interactions at the microscopic level leading to perturbations in complex macromolecular biological systems (cell membranes, subcellular structures) have been postulated. Biological phenomena caused by such perturbations are expected to show a resonant frequency dependence.

### **1.1.2 Sources and control of exposure**

General population exposure from man-made sources of microwave and RF radiation now exceeds that from natural sources by many orders of magnitude. The rapid proliferation of such sources and the substantial increase in radiation levels is likely to produce "electromagnetic pollution". Major man-made sources include: radar installations, broadcasting and television networks, and telecommunication equipment. In industrial, commercial, and home equipment, notably those where energy is applied for heating purposes such as plastic sealing, welding, drying, cooking, and defrosting, there may be extraneous emission (leakage) of microwave or RF radiation.

The problem of this extraneous radiation or pollution from sources of 100 kHz—300 GHz electromagnetic waves varies from country to country, depending on the degree of industrialization. Radiation emitted from high power sources such as broadcasting and telecommunication networks propagates over large distances and may even cover the whole circumference of the globe. With the increasing use of transmitter/receivers by sea and air traffic, and the necessity for ground-based radar control, increased levels of environmental electromagnetic radiation may constitute a problem in many countries.

Problems of pollution range from electromagnetic interference, particularly in relation to the operation of health services, to direct risks to the health of individuals.

### 1.1.3 Biological effects in experimental animals

When sufficient microwave and RF radiation is absorbed and converted into heat there is a consequent rise in temperature in the organism. Injuries that have been studied in animals have resulted from exposure to high levels of radiation and have varied from local lesions and necrosis to gross thermal stress from hyperthermia. Death from hyperthermia was found to occur following exposure to power densities of a few tens of  $\text{mW}/\text{cm}^2$  to several hundreds of  $\text{mW}/\text{cm}^2$ , depending mainly on the size of the animal and the radiation frequency. Recently, there has been a much wider appreciation of the consequences of nonuniform energy deposition (as described in sections 6.3 and 7.1). Lesions have been found in the internal organs of animals exposed for prolonged periods during which there was no significant rise in rectal temperature. Furthermore, such animals did not show any overt signs of distress.

Acute exposures may cause injury to the eye. The cornea and crystalline lens are particularly susceptible to injury within the frequency range of 1—300 GHz. The cornea is at greatest risk between 10 and 300 GHz and the crystalline lens from 1 to 10 GHz. For short-term<sup>a</sup> exposures, the cataractogenic incident power density levels lie within the range of 150—200  $\text{mW}/\text{cm}^2$ . Cataract formation induced by a 1-h exposure can take as long as 10—14 days to develop. The formation of retinal lesions is also possible.

It has been demonstrated that low-level,<sup>b</sup> long-term<sup>a</sup> exposure may induce effects in the nervous, haematopoietic, and immunocompetent cell systems of animals. Such effects have been reported in small animals (rodents) exposed to incident power density levels as low as 0.1—1.0  $\text{mW}/\text{cm}^2$ . The reported effects on the nervous system include behavioural, bioelectrical, metabolic, and structural (at the cellular and subcellular levels) changes. Erythrocyte production and haemoglobin synthesis may be impaired and immunological reactivity changed. All these effects may influence the susceptibility of animals to other environmental factors. For example medium level, long-term exposure increases the sensitivity of animals to neurotropic drugs, particularly those inducing convulsions. Thermal mechanisms seem wholly inadequate to account for the results of studies indicating that cerebral tissue, exposed

---

<sup>a</sup> See Glossary.

<sup>b</sup> In this document, the ranges for low, medium, and high level exposures are approximately those agreed by the Warsaw symposium (section 1.1.4).

to weak electromagnetic fields, responds only over a limited range of intensities and modulation frequencies of the RF carrier field. There appears to be evidence for both amplitude and modulation frequency windows, outside which effects are not observed.

Genetic effects, effects on development, and teratogenic effects have been observed in animals and plants. Numerous reports have indicated that at sufficiently high intensities, microwave and RF exposure may induce chromosomal aberrations, and also disturbances in somatic cell division (mitosis), germ cell maturation (meiosis), and spermatogenesis (section 7.7). The intensity levels required to produce these effects seem to indicate that a thermal mechanism may be responsible. Existing information on the influence of microwave and RF exposure on the transmission and expression of hereditary traits is, however, insufficient. No threshold levels or dose-effect relationships can be established at present.

#### **1.1.4 Power density ranges in relation to health effects**

During the 1973 Warsaw International Symposium on biological effects and health hazards of microwave radiation, it was agreed that microwave power densities could be divided into ranges. The following is an abridged version of this agreement:

Microwave densities may be divided into the following 3 ranges:

- (a) High power densities, generally greater than  $10 \text{ mW/cm}^2$ , at which distinct thermal effects (see Glossary) predominate;
- (b) Medium power densities, between  $1\text{--}10 \text{ mW/cm}^2$ , where weak but noticeable thermal effects exist; and
- (c) Low power densities, below  $1 \text{ mW/cm}^2$ , where thermal effects are improbable, or at least do not predominate.

The boundaries indicated for these ranges are arbitrary and depend on numerous factors, such as animal size, threshold of warmth sensation, frequency, and pulsing. The introduction of the intermediate range of subtle effects calls attention to the need for additional research, aimed at clarification of the underlying mechanisms.

It should be noted that the classification applied to the microwave region (300 MHz—300 GHz). A similar classification was not determined for the RF region (100 kHz—300 MHz).

#### **1.1.5 Exposure effects in man**

The meagre evidence available on exposure effects in man has been obtained from incidents of accidental acute over-exposure to microwaves and RF. Not enough attention has been given to the conduct of epidemiological investigations. In some human studies, which have been conducted on people exposed occupationally, sub-

jective symptoms have been reported.

A considerable number of people in many countries have received microwave and RF diathermy treatment at power levels of several tens of watts for a duration of about 20 min daily over a period of some weeks.

Adverse effects have not been adequately investigated among diathermy patients. This is a group of people exposed to microwaves and RF who can be readily identified and such studies should be carried out, as they may yield considerable information concerning exposure effects in man.

### **1.1.6 Health risk evaluation as a basis for exposure limits**

Theoretical considerations, experimental animal studies, and limited human occupational exposure data constitute the basis for the establishment of health protection standards. It should be noted that, in some countries, microwave and RF health protection standards have recently been changed and that there is a tendency to adopt less divergent exposure limits in comparison with those proposed two decades ago.

In establishing health protection standards, different approaches and philosophies have been adopted.

A highly conservative approach would be to keep exposure limits close to natural background levels. However, this is not technically feasible. A reasonable risk-benefit analysis has to be considered.

More data on the relationship between biological and health effects and the frequency and mode of generation of the radiation, particularly in complex modulations, are needed.

In the case of pulse modulation, peak power density may be a factor which should be considered in setting exposure limits. However, it is not possible to propose a limit of peak power density from the information available at present.

## **1.2 Recommendations for Further Studies, Exposure Limits, and Protective Measures**

### **1.2.1 General recommendations**

The basic biophysical mechanisms of interaction of microwaves and RF with living systems still need clarification and further studies.

Work on both theoretical and experimental dosimetry, the calculation and measurement of fields and of energy deposited within simulated or actual biological systems, should be continued and refined.



Results of animal studies are difficult to extrapolate to man, and these studies alone do not constitute a satisfactory basis for the establishment of health protection criteria. They should, therefore, be supplemented by appropriate epidemiological studies in man.

The existing data on power, amplitude, and frequency "windows" seem to warrant continued investigations.

The effects of chronic exposure on sensitivity to convulsant and other drugs are potentially useful and may have a direct bearing on the development of exposure standards.

Long-term, low-level exposures combined with such stresses as high ambient temperature and humidity should be investigated.

There is little published information on dose-effect relationships; reports tend to be limited to whether effects are observed at one particular level of exposure rather than over a range. More dose-related information, even covering small subject areas, would be valuable.

Investigations on the genetic effects and effects on development of microwave and RF radiation should have priority.

Attention should be given to investigating the different sensitivities to microwave/RF exposure of subgroups within the general population.

National and international agreements on exposure limits, ways and means of controlling this type of environmental pollution, and concerted efforts to implement such agreements are needed.

### **1.2.2 Measurement techniques**

There is a continuing need for the development of microwave/RF measuring instruments that: (a) give direct readings of electric or magnetic field strength, or power density; (b) are robust; (c) are portable, light-weight, and battery-operated; and (d) are sensitive and can be used over a wide frequency range.

The problem of the design of personal dosimeters also remains to be solved.

### **1.2.3 Safety procedures**

Computation techniques or methods that predict the distribution of fields close to deliberate high-power emitters (in the near field) are needed.

Emphasis should be placed on the development of technology to ensure containment and limitation of radiation to the deliberately

exposed object, as well as the reduction of leakage emission from devices.

Personal protective devices should be used only as a last resort.

Adequate medical surveillance of occupationally-exposed persons should be provided.

Once exposure limits have been set, safety guidelines or codes of practice concerning safe use and installation design should be developed as soon as possible.

#### **1.2.4 Biological investigations**

Reports of experimental work should contain sufficient information describing the exposure conditions to allow an estimation not only of the total absorbed energy but also, as far as possible, of the distribution of the energy deposited within the irradiated biological system.

Systematic investigation of the effects of microwave/RF exposure at all levels of biological organization are to be encouraged. This includes effects at the molecular level on subcellular components; cells, viruses, and bacteria; organs and tissues; and whole animals. Particular attention should be paid to: (a) long-term, low-level exposures and possible delayed effects; (b) the possibility of differences in sensitivity of various body organs and systems, where specific effects in various animal species are being considered; and (c) the influence of microwave/RF exposure on the course of various diseases, including any possible increase in sensitivity to microwaves/RF that may result because of the disease state.

#### **1.2.5 Epidemiological investigations**

Epidemiological studies should be carried out in a careful manner, paying attention to the relationship between exposure to microwaves/RF and other environmental factors occurring in the place of work and to the health status of the investigated group. Specific biological endpoints should be selected and adequate examination methods used for such studies. Conventional medical examinations will not provide sufficient information.

Studies should be carried out on (a) workers occupationally exposed to microwave/RF sources; (b) patients treated with microwave and RF diathermy; and (c) groups within the general population living near high-power microwave/RF sources.

A distinction should be made between occupational and public health protection standards.

## 1.2.6 Exposure limits and emission standards

### 1.2.6.1 Occupational exposure limits

The occupationally-exposed population consists of healthy adults exposed under controlled conditions, who are aware of the occupational risk. The exposure of this population should be monitored.

It is possible to indicate exposure limits from available information on biological effects, health effects, and risk evaluation. For occupational exposure, values within the range 0.1—1 mW/cm<sup>2</sup> include a high enough safety factor to allow continuous exposure to any part of the frequency range over the whole working day. Higher exposures may be permissible over part of the frequency range and for intermittent or occasional exposures. Special considerations may be indicated in the case of pregnant women.

### 1.2.6.2 Exposure limits for the general population

The general population includes persons of different age groups and different states of health, including pregnant women. The possibility that the developing fetus could be particularly susceptible to microwave/RF exposure deserves special consideration.

Exposure of the general population should be kept as low as readily achievable and exposure limits should generally be lower than those for occupational exposure.

### 1.2.6.3 Emission standards

Emission standards for equipment should be derived from, and be lower than exposure limits, where this can reasonably be achieved. A class of equipment may be considered safe and exempt from regulations, if hazardous levels of radiation exposure cannot originate from such a source.

### 1.2.6.4 Implementation of standards

The implementation of microwave and RF occupational and public health protection standards necessitates: the allocation of responsibility for measurements of radiation intensity and interpretation of results; and the establishment of detailed radiation protection safety codes and guides for safe use, which indicate, where appropriate, ways and means of reducing exposure.

### 1.2.6.5 *Other protective measures*

Prevention of health hazards related to microwave and RF radiation also necessitates the establishment of rules for the prevention of interference with medical electronic equipment and devices such as cardiac pacemakers, prevention of detonation of electroexplosive devices, and prevention of fires and explosions due to the ignition of flammable material (vapours) by sparks originating from induced fields.

### 1.2.6.6 *Studies related to the establishment of limits*

Studies of the frequency and modulation dependence of biological and health effects are of prime importance. The results of such investigations may make it possible to modify the rationales of present day standards and to identify frequencies at which exposure limits should be lower or higher than those suggested in section 11.

## **2. MAGNITUDE OF EXPOSURE TO MICROWAVE AND RF RADIATION AND SOURCES OF CONCERN**

Electromagnetic fields and RF radiation occur naturally over a very wide range of frequencies. The ionosphere very effectively shields the earth's biosphere from radiations of this type originating in space. Electromagnetic fields and radiation of high intensity may be generated by natural electrical phenomena such as those accompanying thunderstorms.

However, in the frequency range of 100 kHz to 300 GHz, the intensity of natural fields and radiation is low. Exposure of the urban population in the USA to man-made microwave sources was found by Janes (1979) to vary from a very low value to as high as  $100 \mu\text{W}/\text{cm}^2$ . The median exposure to the total microwave flux from external sources for this population was calculated to be  $0.005 \mu\text{W}/\text{cm}^2$ . Osepchuk (1979) has calculated the background exposure from the sun, integrated up to 300 GHz to be  $1.4 \times 10^{-5} \mu\text{W}/\text{cm}^2$ . These values can be put in better perspective by noting that the integrated microwave/RF flux emitted from the human body has been calculated by Justesen (1979) to be up to  $0.5 \mu\text{W}/\text{cm}^2$ .

The proliferation of man-made sources of energy in the 100 kHz—300 GHz range has only occurred over the last few decades. From the point of view of biological evolution, this energy

constitutes a very recent physical factor in the environment. Observations of biological effects from exposure to microwaves gave rise to concern in the early 1940s. On the basis of special research programmes, radiation protection guides recommending exposure limits were developed in the 1950s in the USSR and the USA. Thereafter, several industrialized countries introduced recommendations and/or legislation on microwave and RF health protection. It should be noted, however, that exposure limits vary widely, and are the subject of many discussions and much controversy.

Although concern about microwave and RF effects and possible hazards arose first in highly developed countries, the problem is universal. Developing countries are rapidly establishing telecommunications, broadcasting systems, and other sources of electromagnetic energy. Electromagnetic waves emitted in particular countries may propagate around the globe. A report from the USA (Office of Telecommunications Policy, 1974) states: "Unless adequate monitoring programs and methods of control are instituted in the near future, man may soon enter an era of energy pollution comparable to that of chemical pollution of today."

The urgent need for international agreement on maximum exposure limits and international programmes for the containment of electromagnetic pollution has been stressed at international meetings (Czerski et al., 1974a). Prevention of potential hazards is a more efficient and economical way of achieving control than belated efforts to reduce existing levels.

### **3. PROPERTIES OF MICROWAVE AND RADIOFREQUENCY (RF) RADIATION**

Radiowaves in the frequency range 100 kHz—300 GHz are non-ionizing electromagnetic radiation, and can be described in terms of time-varying electric and magnetic fields moving through space in wavelike patterns, as represented in Fig. 1.

The wavelength (the distance between corresponding points of successive waves) and the frequency (the number of waves that pass a given point in 1 second) are related and determine the characteristics of electromagnetic radiation. The shorter the wavelength, the higher the frequency. At a given frequency, the wavelength depends on the velocity of propagation and therefore, will also depend on the properties of the medium through which the radiation passes. The wavelength normally quoted is that in a

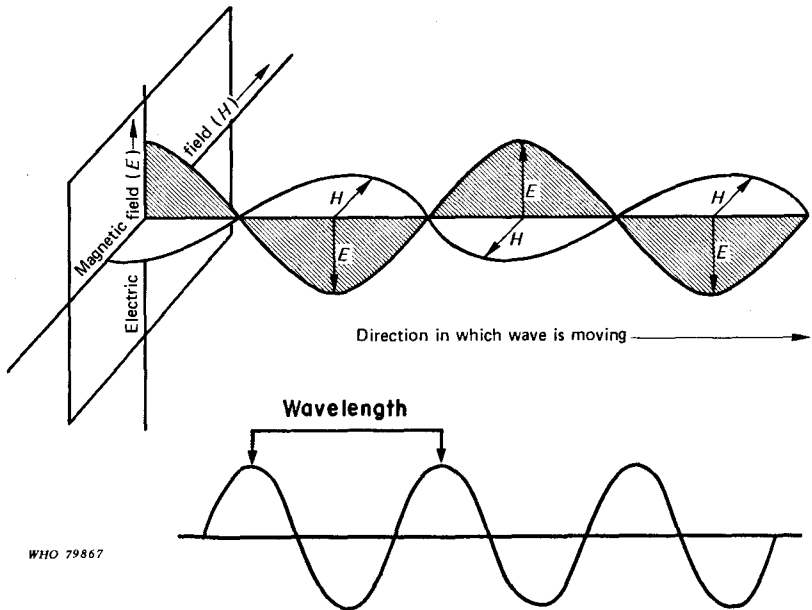

Fig. 1. An electromagnetic monochromatic wave. Electromagnetic waves consist of electrical and magnetic forces which move in consistent wave-like patterns at right angles to one another.

vacuum or air, the difference being insignificant. However, the wavelength can change significantly when the wave passes through other media. The linking parameter with frequency is the velocity of light ( $3 \times 10^8$  m/second in air). The velocity decreases and the wavelengths become correspondingly shorter, when microwaves and RF radiation enter biological media, especially those containing a large proportion of water.

Another related property of electromagnetic waves is the photon energy, which increases linearly as the frequency increases. Fig. 2 shows the spectrum of electromagnetic radiation ranging from highly energetic ionizing radiation with extremely high frequencies and short wavelengths to the less energetic non-ionizing radiation with the much lower frequencies and longer wavelengths of radio-frequencies.

Conventionally a photon energy of 12eV, corresponding to a wavelength of 100 nm, is taken as the dividing line between ionizing and non-ionizing radiation. This is in the vacuum region of the ultraviolet spectrum. Microwave and RF radiations are much less energetic. Their energy per photon corresponds to  $1.25 \times 10^{-3}$  eV at 300 GHz and  $4.1 \times 10^{-10}$  eV at 100 kHz, and is much too low to cause ionization.

$$\begin{aligned}
 1 \text{ mm} &= 10^6 \text{ nm} \\
 10 \text{ mm} &= 1 \text{ cm} \\
 100 \text{ cm} &= 1 \text{ m}
 \end{aligned}$$

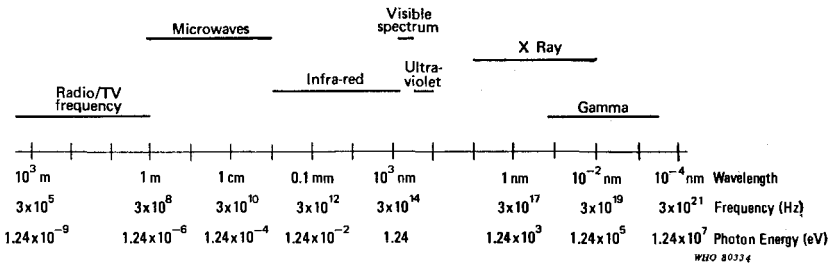

Fig. 2. The spectrum of electromagnetic radiation.

### 3.1 Units of Radiation

When microwave or RF radiation is absorbed in a medium, the most obvious effect is heating. The radiation intensity can be determined calorimetrically. In SI terminology, it is known as the irradiance and is expressed in  $\text{W/m}^2$ . Traditionally, however, the term "power density" has been and continues to be used for this part of the frequency range, and will be used in this document with the more commonly reported units of  $\text{mW/cm}^2$  and  $\mu\text{W/cm}^2$ .

The associated electric and magnetic field strengths ( $E$  and  $H$ ) can be equally valid expressions of radiant energy flow. When these are stated in  $\text{V/m}$  and  $\text{A/m}$ , respectively, their product yields  $\text{VA/m}^2$ . At distances greater than about one wavelength from the source,  $E$  and  $H$  are in phase and  $\text{VA/m}^2$  may be expressed as  $\text{W/m}^2$ . Ideally, at a distance sufficiently remote from the source of radiation that it can be regarded as a point source, an inverse square law of power density with distance applies, the ratio  $E/H$  is  $120 \pi$ , i.e.,  $377 \Omega$ . The power density can, therefore, be derived from  $E^2/377$  or from  $H^2 \times 377$ . Where  $E$  and  $H$  are expressed in  $\text{V/m}$  and

Table 1. Comparison of power densities in the more commonly used units for free-space, far-field conditions

$\text{W/m}^2$	$\text{mW/cm}^2$	$\mu\text{W/cm}^2$	$\text{V/m}$	$\text{A/m}$
$10^{-2}$	$10^{-3}$	1	2	$5 \times 10^{-3}$
$10^{-1}$	$10^{-2}$	10	6	$1.5 \times 10^{-2}$
1	$10^{-1}$	$10^2$	$2 \times 10$	$5 \times 10^{-2}$
10	1	$10^3$	$6 \times 10$	$1.5 \times 10^{-1}$
$10^2$	10	$10^4$	$2 \times 10^2$	$5 \times 10^{-1}$
$10^3$	$10^2$	$10^5$	$6 \times 10^2$	1.5
$10^4$	$10^3$	$10^6$	$2 \times 10^3$	5

A/m (Table 1), this is referred to as plane-wave or far-field conditions and to obtain a measure of the radiated power density, only the  $E$  field or the  $H$  field need be measured. Most instruments used for measuring power density measure the  $E$  field, because this technique is more versatile and presents fewer practical problems.  $H$  field detectors have been devised for a limited range of frequencies. Instruments combining both types of detection are possible, in principle, but would be most difficult to construct.

The distance beyond which far-field conditions apply is usually taken as being  $2a^2/\lambda$ , where  $a$  is the maximum dimension of the source (antenna) and  $\lambda$  is the wavelength. The radiated "near field" includes distances of less than  $2a^2/\lambda$ , where the inverse square law with distance does not apply and the impedance in space (the ratio  $E/H$ ) may differ from  $377 \Omega$ . Close to the source, at distances less than  $\lambda$ , reactive components of  $E$  and  $H$  become progressively more important. Instruments, calibrated in units of power density but based on the measurement of  $E$ , for instance, will become increasingly inaccurate at close range. The instruments make valid measurements of the  $E$  fields, but their scale indications in terms of power density no longer apply. These and allied considerations are also discussed in section 4.3.2.

### 3.2 Other Physical Considerations

A detailed analysis and interpretation of the perturbing effects of objects placed in the path of microwave or radiofrequency beams requires the solution of Maxwell's field equations<sup>a</sup> for the appropriate boundary conditions. However, an important insight can be obtained by comparison with the shorter wavelength visible radiation, to which the same equations apply. The general laws of geometrical and physical optics remain valid: particularly the latter because of the wavelengths involved and because deliberate generators of microwaves and RF emit coherent radiation, i.e., the wave fronts are regular and radiated over a narrow band of frequencies at any one time. Radiation reflected into the path of the incident beam will form standing waves and, at a distance of a few wavelengths, diffraction effects can cause additive and subtractive interference. Both effects have been convincingly demonstrated by Beischer & Reno (1977) at 1 GHz with man as the perturbing influence. Diffraction and internal reflections can also take place when radiation penetrates heterogeneous materials such as body tissues, leading to markedly nonuniform internal

---

<sup>a</sup> A set of four fundamental equations that describe all electric and magnetic fields. Their solution for real materials requires knowledge of the macroscopic electrical and magnetic properties of the materials.



fields and energy deposition. As in geometric optics, the combination of a high refractive index and convex body contours behaves like a strong convex lens focusing the penetrating radiation. Absorption and internal scattering will limit the extent of these effects. Without the absorption of energy to initiate some change, there cannot be any biological effects.

Direct radiation is usually polarized, i.e., the  $E$  and  $H$  fields are oriented parallel to particular orthogonal planes or rotate in an ordered fashion. The plane of polarization of the reflected radiation will, thus, be changed complicating the measurement of the combined beams and investigation of the biological effects. Orientation with respect to the plane of polarization is important in some measuring instruments and in the distribution and total energy absorption in animals and in man. In some radar applications, typical equipment may emit pulses of 1 microsecond ( $\mu s$ ) with a pause between pulses of 1 millisecond (ms). This constitutes a factor of  $10^3$  in the values of instantaneous power radiated and deposited, and of 30 in the electric fields, compared with continuous wave (cw) generation at the same average power. Thus, instruments to be used in pulsed fields must have a wider dynamic range and more robust burn-out characteristics.

## **4. SOURCES AND CONDITIONS OF EXPOSURE**

### **4.1 Natural Background Sources**

Microwave and RF radiation occurs naturally, but the intensity of natural radiation in the range of 100 kHz—300 GHz is very low in comparison with the overall intensity of man-made radiation in this range, as shown in Fig. 3. The intensity of natural fields is mostly due to atmospheric electricity, which is static and has an electric field intensity of about 100 V/m (IVA Committee, 1976). This is known as the earth's electric and magnetic field. Radio emissions of the sun and stars, which are equivalent to about 10 pW/cm<sup>2</sup> in the range of 100 kHz to 300 GHz also contribute to natural radiation. Local disturbances leading to increased field intensities occur during thunderstorms. Electromagnetic fields with a very wide frequency range are created (atmospheric noise) with a maximum field intensity at about 10 kHz (Minin, 1974; IVA Committee, 1976).

Artificial microwave and RF radiation constitutes a very recent environmental factor, dating back only a few decades. Depending

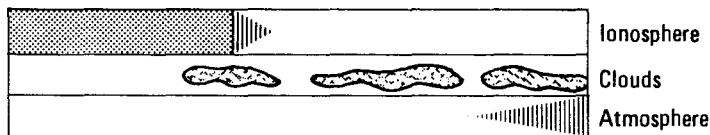
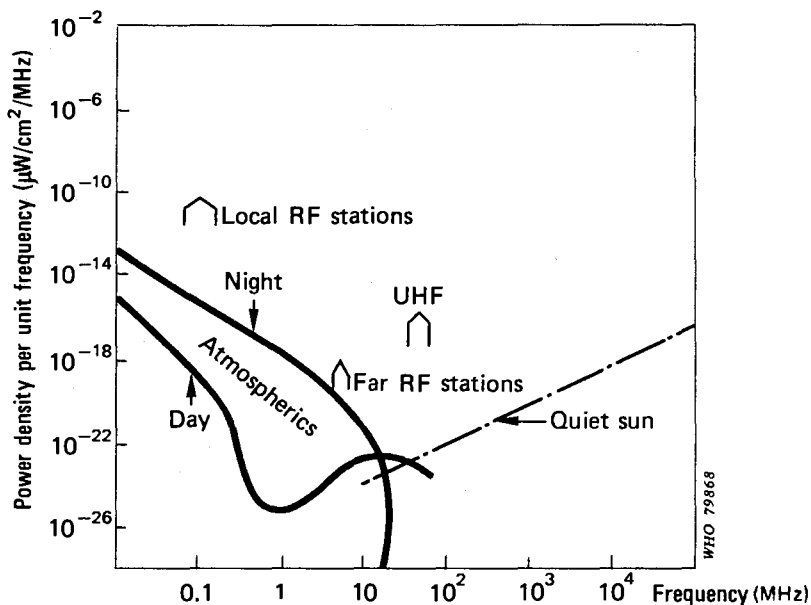

Fig. 3. Comparison of natural background and man-made RF and microwave radiation (From: Minin, 1974).

on the frequency range, exposure from man-made sources of microwave and RF radiation may be many orders of magnitude higher than that from natural radiation and man as a species has had no opportunity to adapt to microwave and RF radiation at such environmental levels (Presman, 1968).

There exists a great diversity of man-made sources, both in respect of power output and the power densities that are generated, and the frequency range in which the sources operate. According to the use of the source, different segments of the general population are exposed in different ways. There are obvious differences, depending on the development of the country, between the average exposure of the general population, the exposure of inhabitants of urban industrialized areas, and the exposure of inhabitants of rural areas. There is also a risk of exposure to microwaves and RF in

some occupations. In view of this, the discussion of man-made sources must include a description of exposure situations.

## **4.2 Man-Made Sources**

Any appliance that generates electricity or is driven by an electric current generates electromagnetic fields. These propagate through space in the form of electromagnetic waves. Man-made microwave and RF sources may be broadly divided into 2 classes, i.e., deliberate emitters, and sources of unintentional, incidental radiation.

### **4.2.1 Deliberate emitters**

Deliberate emitters generally have a radiating element (antenna) designed to emit electromagnetic waves into the surrounding environment in a specified manner. The frequency, direction of propagation, and the point of origin are determined by the intended use of the equipment. Because of physical laws, and, in spite of the degree of perfection of the design of a deliberate emitter, some unintentional leakage, or stray radiation is always generated. This should be taken into account when evaluating a deliberate emitter as a radiation source.

Unintentional radiation may occur in the form of broad-band noise or may be generated as discrete harmonics. In some instances, it is generated by sources that emit radiation outside the microwave and RF ranges. For example, while the intentional radiation of fluorescent light tubes lies in the visible light range, such tubes also generate very low levels of microwave and RF white noise (Mumford, 1949).

Typical deliberate emitters include radiobroadcasting and television stations, radar installations, and electronic wireless communication systems. These sources can be classified in different ways and classifications may vary from country to country depending on attitudes towards possible environmental and health effects. When classified according to the nominal power output or the effective radiated power (ERP), such emitters may be divided into high, medium, and low power sources. Radar systems used for tracking and guiding purposes, as well as sources used in satellite systems are among the most powerful. It was reported in 1974 in the USA, that there were 20 nonpulsed unclassified sources with average effective radiated power (ERP) ranging from 5 GW to 31.6 GW and one experimental source with an average ERP of

3.2 TW ( $3.2 \times 10^{12}$ W) (Hankin, 1974). All these sources were used in conjunction with satellite systems. A further 144 sources had an average ERP of 1 MW or more. The twenty most powerful unclassified pulsed (radar) sources had average ERPs between 8.7 MW and 840 MW and peak ERPs ranging from 35.4 GW to 2.8 TW; 229 unclassified pulsed sources had peak ERPs of 10 GW or more. This may be compared with television or amplitude modulation (AM) broadcasting stations in which the power of the transmitters is of the order of tens of kW (usually about 50 kW) or radio telephones (walkietalkies), in which ERPs may be of the order of a few watts or less.

Another approach towards classification of sources is to examine the configuration of the radiated fields and their propagation in space. Directional radiating elements (antennae) generating intense focused beams and multidirectional, variously polarized antennae may be used. Taking into account the power of the transmitter and the type of the radiating element, the magnitude of distances (or zones) at which various intensities of radiation (power densities on strength of  $E$  or  $H$  fields) occur can be computed. In this case, the classification of sources also depends on arbitrarily chosen levels of radiation intensity. This approach may be useful in the siting of sources and in establishing "safe", "hazardous", and "danger" zones around a source.

Deliberate emitters may be also classified according to the mode of generation. Microwaves and RF may be generated continuously or in pulses and both continuous and pulsed wave generators may operate for long periods (up to 24 h per day) or short intermittent periods. The generated radiosignal may be frequency, amplitude, or pulse-modulated. Sources with moving directional antennae and sources generating mobile narrow beams may illuminate a point in space intermittently with a time-varying intensity ranging from zero to extremely high, at pulse peak power. Because of these complexities and since a point in space may be illuminated by radiation originating from several sources, the determination of the total or average quantity of energy delivered at this point during a period of time, may be difficult and may necessitate the use of sophisticated equipment and advanced computing methods.

Evaluations of the intensity of microwave and RF radiation generated by deliberate emitters have been published in the USA (Smith & Brown, 1971; Tell, 1972; US Environmental Protection Agency, 1973; Tell & Nelson, 1974a; Tell et al., 1974; Hankin et al., 1976; Stuchly, 1977; Tell & Janes, 1977; Tell & Mantiply, 1978). Fig. 4—7 illustrate the number of sources operating in the frequency range 10 kHz—300 GHz and capable of producing power densities

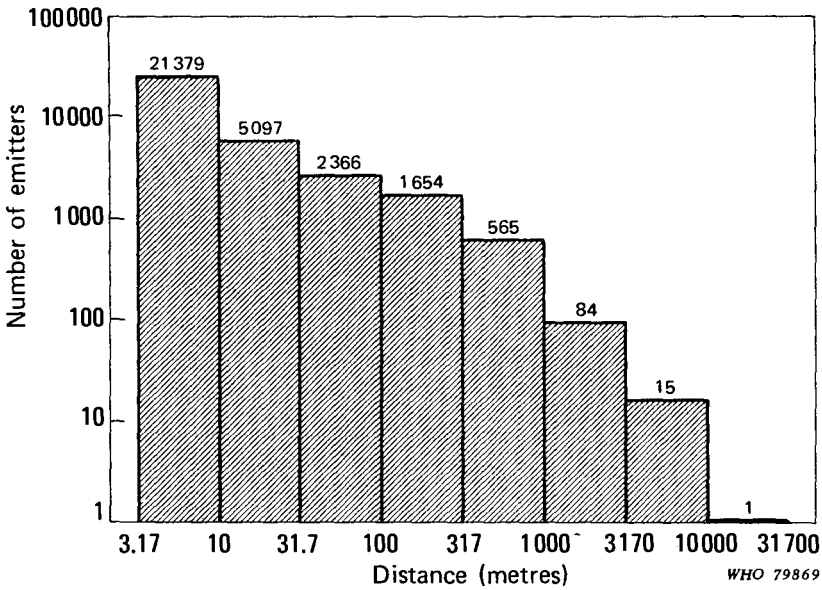

Fig. 4. Microwave sources in the USA in 1973, capable of producing a power density equal to or greater than 10 mW/cm<sup>2</sup> (From: National Health and Welfare, Canada (1977) based on Rowe et al., 1973).

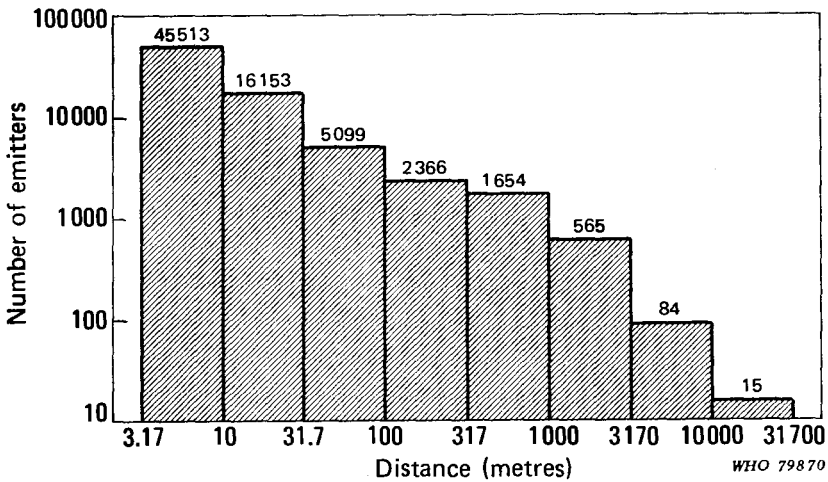

Fig. 5. Microwave sources in the USA in 1973, capable of producing a power density equal to or greater than 1 mW/cm<sup>2</sup> (From: National Health and Welfare, Canada (1977) based on Rowe et al., 1973).

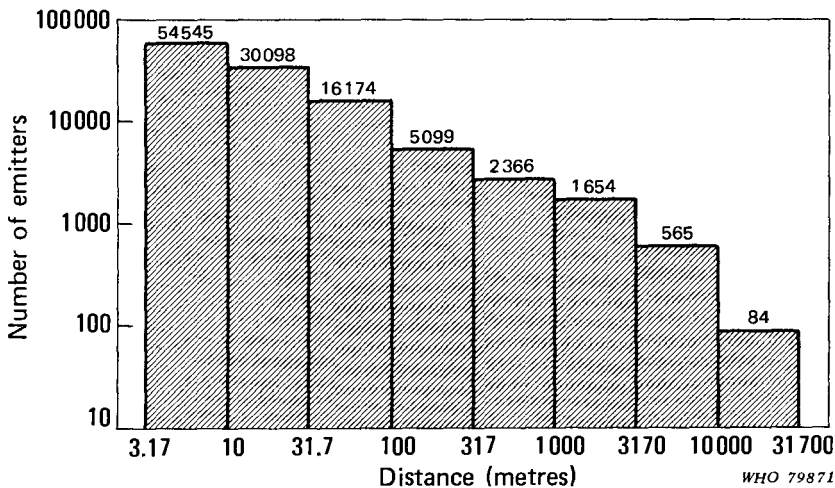

Fig. 6. Microwave sources in the USA in 1973, capable of producing a power density equal to or greater than  $0.1 \text{ mW/cm}^2$  (From: National Health and Welfare, Canada (1977) based on Rowe et al., 1973).

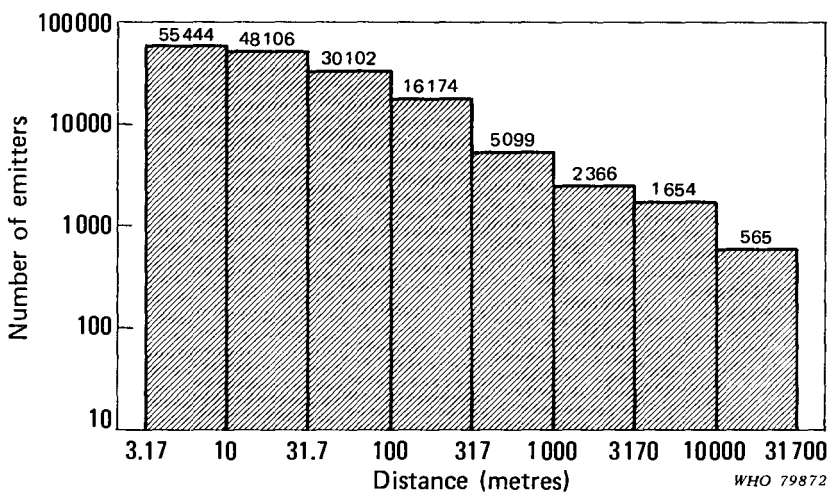

Fig. 7. Microwave sources in the USA in 1973, capable of producing a power density equal to or greater than  $0.01 \text{ mW/cm}^2$  (From: National Health and Welfare, Canada (1977) based on Rowe et al., 1973).

equal to or greater than 10 mW/cm<sup>2</sup>, 1 mW/cm<sup>2</sup>, 0.1 mW/cm<sup>2</sup>, and 0.01 mW/cm<sup>2</sup>. These data should be compared with data in Tables 2—6.

Table 2. Anticipated characteristics of selected satellite communication systems<sup>a</sup>

System	f(GHz)	P <sub>av</sub> (kW)	P <sub>max</sub> (mW/cm <sup>2</sup> )	Distance in km from antenna for power densities of		
				0.1 mW/cm <sup>2</sup>	1 mW/cm <sup>2</sup>	10 mW/cm <sup>2</sup>
LET	8.1	2.5	30.4	0.246	0.78	2.46
AN/TSC-54	8.1	8	50.8	0.46	1.45	4.58
AN/FSC-9	8.1	20	7.6	6.23	19.7	62.3
Intensat	6.25	5	0.73	—	—	12.3
Goldstone Venus	2.38	450	97.3	4.16	13.2	41.6
Goldstone Mars	2.38	450	16.8	9.68	33.4	106

<sup>a</sup> From: National Health and Welfare, Canada (1977) based on Hankin et al. (1976).

Table 3. Anticipated characteristics of typical high peak power radars<sup>a</sup>

System	f(GHz)	P(kW)	P <sub>max</sub> (mW/cm <sup>2</sup> )	Distance in km from antenna for power densities of		
				10 mW/cm <sup>2</sup>	1 mW/cm <sup>2</sup>	0.1 mW/cm <sup>2</sup>
Acquisition radar FPN — 40	9.0	0.18	12.8	0.028	0.111	0.351
Acquisition radar ARSR	1.335	20	111	0.147	0.465	1.47
Tracking radar Hawk Hi Power	9.8	4.7	800	0.108	0.344	1.08
Tracking radar no. 1	2.85	12	34.2	0.392	1.24	3.93
Tracking radar no. 2	1.30	150	55.7	1.75	5.52	17.5

<sup>a</sup> From: National Health and Welfare, Canada (1977) based on Hankin et al. (1976).

Table 4. Experimental data for typical on-board aircraft radars<sup>a</sup>

Radar system	Aircraft	f(GHz)	Power average (W)	Power density max. (mW/cm <sup>2</sup> )	Approximate distance from radome in m for power density of	
					10 mW/cm <sup>2</sup>	1 mW/cm <sup>2</sup>
WP 103	BAC 111	9.375	26	20	3	11
AVQ 20	Convair	9.375	18	10	2	11
AVQ 50	Convair 580	9.375	16	26	2	11
AVQ 20	DC-9	9.375	28	15	4	13

<sup>a</sup> From: National Health and Welfare, Canada (1977) based on Tell & Nelson (1974a).

Table 5. Power density in the vicinity of on-board marine radars (non-rotating antennae)<sup>a</sup>

System	f(GHz)	Peak (kW)	Power Average (W)	Distance from antenna (m)	Average power density ( $\mu\text{W}/\text{cm}^2$ )	
Decca 101	9.445	3	3.25	25.5	6.8	$7.5 \pm 5.4$
Decca 202	9.445	3	1.5	45.7	3.6	$5.1 \pm 4.6$
Decca RM316	9.41	10	5	103.6	3.7	$5.9 \pm 5.0$
Kelvin-Hughes 17	9.445	3	2.75	103.6	0.6	1.4
Konel KRA 221	9.375	10	4.8	45.7	9.2	$6.1 \pm 4.5$

<sup>a</sup> From: National Health and Welfare, Canada (1977), based on Peak et al. (1975).

Table 6. Parameters of broadcasting transmitters<sup>a</sup>

Service	Frequency (MHz)	Maximum ERP (kW)	Tower Height (m)	Field intensity (mV/m)	Power density ( $\mu\text{W}/\text{cm}^2$ )
FM Radio	88—108	100	152	1023	2.78
VHF-TV, ch. 2—6	54—88	100	305	807	1.73
VHF-TV, ch. 7—13	174—216	316	305	191	0.1
UHF-TV	470—890	5000	305	380	0.38

<sup>a</sup> From: National Health and Welfare, Canada (1977), based on Tell (1972).

Table 2 presents anticipated characteristics of satellite communications systems, which are among the most powerful sources of continuous wave radiations ( $100 \text{ W}/\text{m}^2$ ,  $10 \text{ W}/\text{m}^2$ ,  $1 \text{ W}/\text{m}^2$ , and  $0.1 \text{ W}/\text{m}^2$ ). Table 3 presents characteristics of pulsed wave, high power generators, and Tables 4 and 5 include characteristics of on-board aircraft and marine radars, respectively. Table 6 shows the characteristics of some North American broadcasting transmitters, the electric field intensity, and the equivalent power density at ground level at a distance of one mile from the transmitter tower. Fig. 8 presents power density versus distance for a television transmitter. In this context, it should be stressed that according to data of the US Environmental Protection Agency (Tell, 1972; Hankin et al., 1976; Tell & Mantiply, 1978) and the US Bureau of Radiological Health (Smith & Brown, 1971), broadcasting stations are "significant sources of RF exposure" (Tell & Janes, 1977). In view of the increasing popularity of mobile (portable or mounted on vehicles) transmitters for personal use, field intensities in the vicinity of antennae of these citizen band (CB) transmitters may be of concern in some countries from the point of view of population exposure (Neuksman, 1978; Ruggera, 1979).

Medical microwave and RF equipment (chiefly medical diathermy) is a particular class of deliberate emitters designed and used



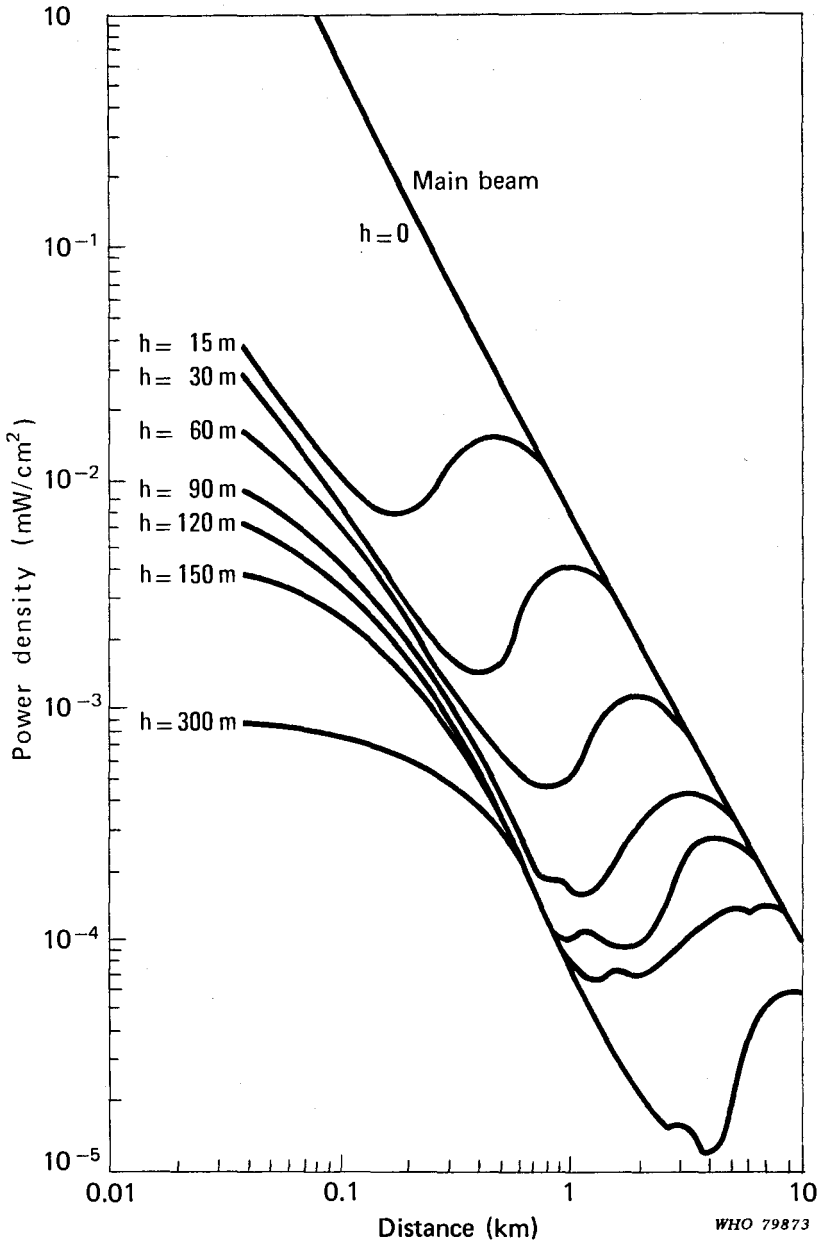

Fig. 8. Power density versus distance at various heights for a TV station with ERP equal to  $1 \text{ mW}/\text{cm}^2$  (From: National Health and Welfare, Canada, 1977).

for the irradiation of human subjects to obtain beneficial effects. In this case, the intended human exposure is carried out under professional supervision and constitutes part of medical practice. The contribution of medical uses to the general population exposure is difficult to evaluate and varies from country to country. A survey in Pinellas County (Florida, USA) revealed that among a population of 500 000 persons, 7037 individuals received 45 000 microwave or shortwave diathermy treatments of various durations and exposure levels (Remark, 1971). It should be pointed out that the county has a large population of retired people.

Although individual patients may absorb large quantities of energy, the exposure is limited to selected body areas and limited in time. However, medical microwave and RF equipment is also a source of unintentional radiation (Bassen et al., 1979) and during irradiation sessions, considerable scattering of electromagnetic fields may occur (Witters & Kantor, 1978; Bassen et al., 1979). Thus, particular attention should be paid to limiting exposure to the areas intended and to avoiding additional radiation doses to the patient from adjacent sources (other diathermy equipment). The occupational exposure of personnel operating the equipment should also be limited. The unintentional exposure of both patient and personnel usually involves the whole body.

#### **4.2.2 Sources of unintentional radiation**

Electrical and electronic, industrial or commercial equipment and consumer products in which, by design, the electromagnetic energy is contained within a restricted area, but into which objects to be processed are introduced, can all be sources of unintentional radiation. Any energy (radiation) emanating outside the area represents an energy loss. However, complete containment of electromagnetic energy is not always technically feasible. A typical example of a source of unintentional or leakage radiation is the microwave oven for commercial or home use. The microwave energy should be totally contained in the oven's cavity and used for heating (cooking) food. Leakage of microwaves does not serve any purpose and, if excessive, may represent a hazard to the user.

Microwave and RF equipment is used in many industries for such processes as melting, welding, drying, gluing, plastic processing, and sterilization. Surveys of dielectric radiofrequency heaters in Canada (Stuchly et al., 1980; National Health and Welfare, Canada, 1980) have shown that these heaters are used predominantly for plastic sealing and wood gluing, and operate at frequencies between 4 and 51 MHz with output powers in the range of 0.5—90 kW. Operators of some of these devices were exposed to fields with equivalent power densities exceeding 10 mW/cm<sup>2</sup>. Most industries use electrical

and electronic equipment (NIOSH, 1973). Table 7 represents various uses of microwave and RF generating equipment within certain frequency bands. Table 8 shows frequencies allocated for industrial, scientific, and medical uses (ISM bands) and Table 9, the frequencies allocated for these purposes in the USA and the USSR.

Table 7. Selected examples of the typical uses of equipment generating radiofrequency and microwave radiation

Frequency	Use	Occupational exposure
Below 3 MHz	Metallurgy: eddy current melting, tempering; broadcasting, radiocommunications, radio-navigation.	Metal workers; radiotransmitter personnel.
3-30 MHz	Many industries such as the car, wood, chemical, and food industries for heating, drying, welding, gluing, polymerization, and sterilization of dielectrics; agriculture; food processing; medicine; radio-astronomy; broadcasting.	Various factory workers, e.g., furniture veneering operators, plastic sealer operators, drug & food sterilizers, car industry workers; medical personnel; broadcasting transmitter and television personnel.
30-300 MHz	Many industries as above; medicine; broadcasting, television, air traffic control, radar radio-navigation.	Various factory workers, as above; medical personnel; broadcasting transmitter and television personnel.
300-3000 MHz	TV, radar (troposcatter and meteorological); microwave point-to-point; telecommunication telemetry; medicine; microwave ovens; food industry; plastic preheating.	Microwave testers; diathermy and microwave diathermy operators and maintenance workers; medical personnel; broadcasting transmitter and television personnel; electronic engineers and technicians; air crews; missile launchers; radar mechanics and operators and maintenance workers.
3-30 GHz	Altimeters; air- and ship-borne radar; navigation; satellite communication microwave point-to-point.	Scientists including physicists; microwave development workers; radar operators; marine and coastguard personnel; sailors, fishermen and persons working on board ships.
30-300 GHz	Radiometeorology; space research; nuclear physics and techniques; radio spectroscopy.	Scientists including physicists; microwave development workers; radar operators.

Table 8. Designation and use of microwave and RF Bands

Letter designation of microwave frequency bands	Frequency — MHZ	Some industrial, scientific, and medical (ISM) frequency bands. (not applicable in all countries)
L	1100— 1700	13.56 MHz ± 6.78 kHz
LS	1700— 2600	27.12 MHz ± 160 kHz
S	2600— 3950	40.68 MHz ± 20 kHz
C	3950— 5850	433 MHz ± 15 MHz
XN	5850— 8200	915 MHz ± 25 MHz
X	8200—12 400	2450 MHz ± 50 MHz
Ku	12 400—18 000	5800 MHz ± 75 MHz
K	18 000—26 500	22 125 MHz ± 125 MHz
Ka	26 500—40 000	

Table 9. Radiofrequency and microwave band designations

Band designations					
USA	USSR				
<i>(a) Radiofrequency bands</i>					
Low frequency	(LF) Long	VCh	$10^4$ — $10^9$ m	30—300 kHz	radionavigation; radio beacon AM broadcast.
Medium frequency (MF)	Medium	(HF)	$10^3$ — $10^2$ m	0.3—3 MHz	marine radiotelephone; AM broadcasting.
High frequency	(HF) Short	UHF	$10^2$ —10 m	3—30 MHz	amateur radio; citizens band in the USA, etc.; world-wide broadcasting; medical diathermy; RF sealers, welders, heaters; short-wave diathermy.
Very high frequency (VHF)	Ultra-short (metre)		10—1 m	30—300 MHz	Frequency modulated (FM) broadcasting; television; air traffic control; radionavigation.
<i>(b) Microwave bands</i>					
Ultra high frequency (UHF)	Decimetre	Super HF		0.3—3 GHz	microwave diathermy; television; microwave point-to-point; microwave ovens & heaters; telemetry; tropo scatter & meteorological radar.
Super high frequency (SHF)	Centimetre (SHF)		10—1 cm	3—30 GHz	satellite communication; airborne weather radar; altimeters; shipborne navigational radar; microwave point-to-point; amateur radio.
Extra high frequency (EHF)	Millimetre		1—0.1 cm	30 GHz—300 GHz	cloud detection radar.

Unintentional exposure to microwave and RF radiations from deliberate emitters occurs universally. The results of a series of investigations by the US Environmental Protection Agency (section 4.2.1) indicate that urban populations in highly industrialized countries may be exposed to overall intensities of the order of  $\mu\text{W}/\text{cm}^2$  (Gordon, 1966; Marha et al., 1971; Minin, 1974; Dumanski et al., 1975; Baranski & Czernski, 1976; Johnson et al., 1976; IVA Committee, 1976; National Health and Welfare, Canada, 1977, 1978; Durney et al., 1978). Inhabitants of high buildings in the vicinity of the rooftop antennae of broadcasting and television stations may be exposed to levels ranging from a few hundred  $\mu\text{W}$  to a few mW per  $\text{cm}^2$ . According to Tell & Mantiply (1978), 50% of the urban population of the USA is exposed to less than  $0.005 \text{ mW}/\text{cm}^2$ , 95% to less than  $0.01 \text{ mW}/\text{cm}^2$ , and 99% to less than  $0.1 \text{ mW}/\text{cm}^2$ .

General population exposure may be considered as long-term, very low-level, intermittent exposure for 24 h per day (or for major portions of the day) to a very wide range of microwave and RF radiation frequencies.

## 4.3 Estimating Exposure Levels

### 4.3.1 Far-field exposure

Estimates of far-field exposures are necessary before powerful and complex installations are constructed. The subject is discussed at length by Minin (1974), who not only considers factors connected with equipment and the local topography but also gives information on methods of screening. Whenever possible, estimates of radiation fields should be made before detailed surveys of potentially hazardous exposures are carried out. Mumford (1961) gives approximate formulae for some radar antennae; additional information can be obtained from textbooks and monographs (Kulinkovskaja, 1970; ANSI, 1973; US Department of Commerce, 1976; National Health and Welfare, Canada, 1977; Krylov & Jucenkova, 1979). This procedure is necessary not only to select a suitable survey instrument but also to determine if potentially hazardous exposure of the operator could occur, if the instrument were faulty. Unlike instruments for ionizing radiation, there are no sources readily available for checking the calibration of the instrument.

In the far field on the antenna axis, power density ( $P_d$ ) can be calculated from the formula:

$$P_d = GP_t/4\pi d^2 = A_e P/\lambda^2 d^2$$

where  $G$  is the far-field gain,  $P_t$  is the power delivered to the antenna (W),  $d$  is the distance from the antenna (m),  $\lambda$  is the wavelength (m) and  $A_e$  is the effective area of the antenna ( $m^2$ ).  $G$ , the far-field gain of the antenna, represents the ratio of the observed power density, on axis, to the power density from a point source having the same output power and emitting equally in all directions.

### 4.3.2 Near-field exposure

When the distance is not great compared with the antenna dimensions, the power density tends to vary inversely with  $d$  instead of  $d^2$  (as in the far field), and may display interference patterns. Radiations from different parts of the antenna, having the same wavelength, combine in various phases. For parabolic antennae, the maximum power density ( $P_d$ ) expected in the radiated near field can be estimated from:

$$P_d = 4P_t/A_e$$

where  $P_t$  is the transmitted power and  $A_e$  is the effective area of the antenna. This expression will generally overestimate the power density. A fuller discussion of this relationship is provided by Hansen (1976) and Hankin et al. (1976).

Effects of ground reflections could increase  $P_d$  by a factor of 4 or even more if focusing effects are present. These predicted values of maximum power density should be within  $\pm 3$  dB (i.e., within a factor of the true maxima for most horn antennae and circular reflector antennae). However, different antenna illumination functions may produce near-field power densities that may be higher than those predicted. It should be recognized that the equation is only suitable for obtaining approximate power densities to use as a rough guide. More precise values require careful measurements (Bowman, 1970, 1974; Ruggera, 1977).

In the case of low frequencies or large aperture antennae, the existence of potentially hazardous reactive near fields becomes relevant. These electric and magnetic fields are calculable only with reference to the geometry of the specific antenna and source. For instance, exact equations for the electric and magnetic fields generated by a small electric dipole contain terms in  $\lambda/d$ ,  $\lambda/d^2$ , and  $\lambda/d^3$ . When  $d$  is much smaller than  $\lambda$ , the  $\lambda/d^3$  terms predominate and this is referred to as the reactive near field. Objects within this region may couple with the source and extract energy. When  $\lambda/d$  approaches 1, all terms contribute and this is sometimes called the intermediate field. When  $\lambda/d$  is substantially less than 1, the conditions are those of the far field.

#### 4.4 Facilities for Controlled Exposure

Controlled exposure facilities are required for the calibration of instruments used in measuring power density, for the exposure of experimental animals in the study of effects, and for the exposure of phantoms (models) and carcasses in studies on absorbed energy and its distribution. The unrepeatability of much of the early biological work has been ascribed to the inadequacy of exposure facilities. Large gradients in field intensities are very undesirable and preferred methods make use of either far-field exposures carried out under conditions in which reflections are reduced to a minimum (e.g., in anechoic chambers), or using guided wave techniques. The basic premise is that known exposure conditions can be established by a combination of measurement and calculation. Except in laboratories with a responsibility for maintaining primary standards, it is probably preferable to use the far-field or guided wave methods to obtain suitable exposure conditions, and to measure the radiation field using an instrument that has been calibrated at a primary laboratory.

The methods of instrument calibration have been described in detail by Engen (1973), Baird (1974), and Bassen & Herman (1977) and are summarized in the following section. The principles apply equally to animal exposure.

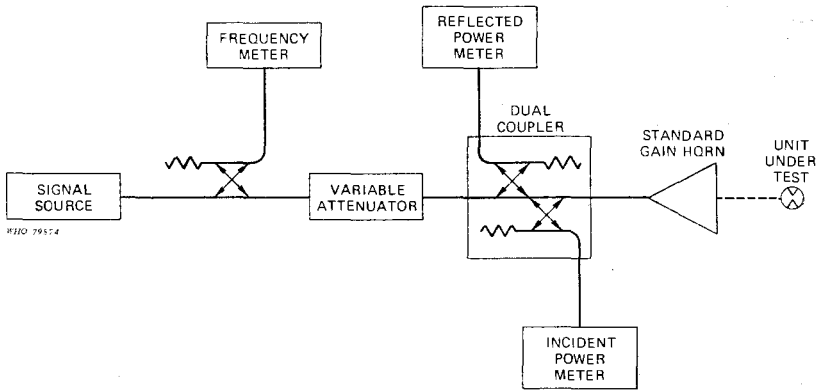

Fig. 9. Diagram of the basic experimental arrangement required for the free space standard field method.

#### 4.4.1 Free space standard field method

There are several variations of this method, but the objective is always to establish a known calibration field in free space. The most common experimental arrangement is shown in Fig. 9. As discussed in section 4.3.1, the power density ( $P_d$ ) at a point on the transmitting antenna is given by:

$$P_d = GP_t/4\pi d^2$$

where  $P_t$  is the power delivered to the transmitting antenna,  $G$  is the effective gain of the transmitting antenna, and  $d$  is the distance from the antenna. The gain is normally determined in advance, and  $P_t$  and  $d$  are measured as part of the regular calibration procedure.

The most convenient method of determining  $P_t$  is by sampling forward or incident and reflected powers. The incident power  $P_i$  and the reflected power  $P_r$  are monitored, and  $P_t$  is obtained from the relation  $P_t = P_i - P_r$ . The high quality, broadband equipment available together with methods for its use in determining  $P_i$  are described in Bramall (1971), Engen (1971), Aslan (1972), and Bowman (1976). The methods cited are for calibrating power meters, but the same techniques can be applied for the calibration of antennae, if corrections are made for mismatch effects, including those from animal exposure.

The principal sources of error in the free space method are multipath interference and uncertainties in the determination of gain. Multipath effects have often been overlooked, but every calibrating facility will have some reflections associated with the walls, equipment, and probe support structure. These reflections may cause the field in the calibrating region to be significantly dif-

ferent from that predicted. Even high-quality anechoic chambers are not perfect and should be evaluated, if the greatest accuracy is desired. Calibration errors due to multipath effects can be reduced by observing the probe response as a function of position and averaging the results. This is sometimes referred to as the multiple position averaging technique and useful discussions of the method can be found in Bowman (1974), Bassen & Herman (1977), Swicord & Cheung (1977), and Swicord et al. (1977).

#### 4.4.2 Guided wave methods

The fields inside a waveguide can be accurately calculated and, in some cases, are sufficiently uniform to be considered for calibration purposes (Hudson, 1966; Hudson & Saulsbury, 1971). The main advantage of such a system is that it requires considerably less power and space. One disadvantage is that the maximum transverse dimension of a rectangular waveguide must be less than the free space wavelength of the highest calibration frequency, in order to avoid higher order modes which result in complicated field distributions. Thus, the method is generally used for frequencies below 2.6 GHz, since the device being calibrated must be small compared with the guide dimension.

The probe to be calibrated is usually inserted into the waveguide through a hole in the side wall and positioned in the centre of the guide, where the field is most nearly uniform. It is difficult to estimate the total uncertainty of this method, because the field intensity will be modified by the size and nature of the probe being calibrated. A careful error analysis of this problem has not been completed, but it appears that, if the maximum probe dimension is less than one third of the smaller waveguide dimension, the total uncertainty should not exceed  $\pm 1$  dB (22%). Woods (1969) described a system which operated from 400 to 600 MHz with an estimated uncertainty in the field intensity of  $\pm 0.5$  dB (12%). Later results at 2450 MHz have been reported by Aslan (1972) with claims of higher accuracy.

Other types of guided wave structures can be used reliably to establish uniform fields for calibration purposes in the RF frequency range below about 500 MHz, where free space techniques become difficult and standard waveguides are unavailable or inconvenient. The two most commonly used structures are the parallel plane line and the Transverse Electromagnetic Mode (TEM) cell (Crawford, 1974). Both structures can be used to produce transverse electromagnetic waves with the same wave impedance ( $377\Omega$ ) as a plane wave in free space, a feature which makes them desirable for calibration purposes. Furthermore, the fields can be calculated with sufficient accuracy for many calibration purposes.



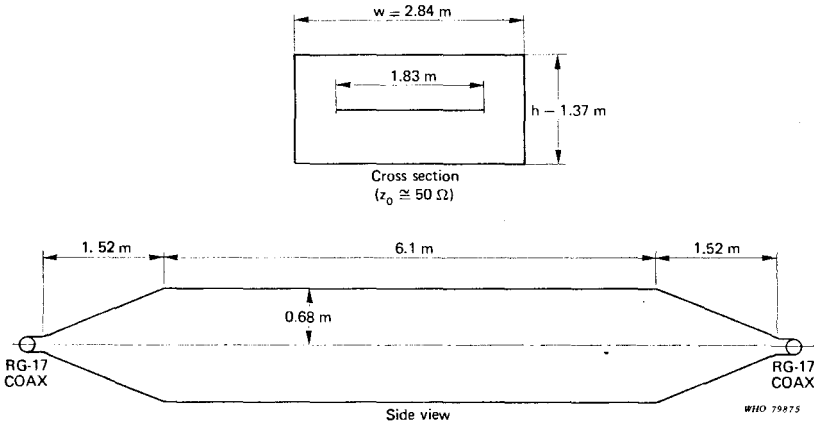

Fig. 10. A type of TEM transmission cell used at the US National Bureau of Standards for calibrating hazard meters and for measuring the susceptibility of electronic equipment to EM fields. Such cells can also be used as exposure chambers for studying biological effects. This cell was designed for an upper frequency limit of about 500 MHz.

A basic TEM cell is illustrated in Fig. 10. The principal advantage of this structure over the parallel plane line is that the TEM cell is fully shielded, thus eliminating extraneous radiation that may interfere with electronic equipment. The basic unit is a section of two conductor transmission lines. As shown in the figure, the main body of the cell consists of a rectangular outer conductor and a flat centre conductor located midway between the top and bottom walls. The field intensity in the centre of the cell can be quite uniform, and the wave impedance throughout the cell is very close to the free space wave impedance. It is mainly because of these features that this type of cell is used for calibrations.

The dimensions of such a cell are adjusted according to the desired upper frequency limit.

**4.4.3 Standard probe method**

A stable and reliable probe, which has been accurately calibrated by one of the previously described techniques, a "transfer standard", is used to measure the field intensity over a particular region in space (or in a guided system) produced by an arbitrary transmitting antenna. The probe to be calibrated is then placed in the same location in the field and the meter reading compared with the known value of the field. The only requirements are that the

transmitter should generate a field which has the desired magnitude, is constant in time, and is sufficiently uniform over the calibrating region. Accuracies of about  $\pm 0.5$  dB (12%) should be attainable. This method is the simplest, and may ultimately prove to be the best method of calibrating hazard meters for general field use Baird (1974). The advantages of this method are its convenience, reliability, and simplicity. Potential sources of error, when using the transfer standard to calibrate another probe, are the possible differences in the receiving patterns of the two probes, especially in the near fields of a source of radiation, and the errors due to scattering from probes under test.

## 5. MEASURING INSTRUMENTS

### 5.1 General Principles

Most power density instruments are composed of 3 basic parts: the sensor, connecting leads, and meter unit. This configuration reduces perturbation of the field in the immediate vicinity of the sensor to a minimum and, in surveys of potentially hazardous equipment, may help in reducing the exposure of the operator. Neither leads nor meter unit should respond to the radiation being measured or serious error can ensue. The instrument should respond only to microwave and RF fields and not, for instance, to light and infrared radiation, or to static and low-frequency electric and magnetic fields. Comparatively few instruments are likely to meet these requirements in full.

The basic principles of instrument calibration with the uncertainties associated with the different methods have already been discussed in section 4.4. The same accuracy cannot be expected or achieved when using the meters for making practical measurements in surveys because: (a) hazard meters are usually calibrated in nominally plane-wave fields, which are seldom encountered in practice, and the sensor may not respond in the same way to non-planar fields; and (b) in most calibration methods, only the sensor (probe) is exposed to the field, while, in practice, the complete system, including the indicating unit and connecting cable, is immersed in the field. Even when these do not respond to the radiation, the radiation fields will be perturbed by their presence and that of the operator. If good measurement procedures are followed, accuracies of 2 dB can be achieved.

## 5.2 Types of Instruments in Common Use

### 5.2.1 Diode rectifier

In these instruments, small antennae terminate in single or multiple diodes. Multiple diodes and antenna elements arranged in suitable configurations can be used to sum all electric field components enabling measurements to be made, irrespective of polarization and direction of incidence. Three orthogonal elements are necessary and sufficient for such an isotropic instrument.

Some units, now in use, employ a single diode combined with a short dipole or small loop antenna. The sensitivity of these instruments changes with their orientation, with respect to the plane of polarization of the  $E$  or  $H$  field. They must, therefore, be oriented so that the maximum value can be read — a process that can be tedious and time-consuming. Such instruments are, however, useful for identifying and measuring individual field components.

An orthogonal dipole array or multiple diodes and dipoles arranged in a single plane will respond well to all signals polarized in the plane of the array, but not to components polarized at wide angles to the array. Such units must also be oriented to obtain the maximum field readings.

All these instruments are basically power density sensitive in the far field, that is, at low levels, the rectified voltages are proportional to the square of the  $E$  field (i.e., to the power density). When adapted to broadband operation, the upper frequency range is, at present, about 18 GHz. The corresponding low frequency limit is about 0.5 MHz.

Diode characteristics depend directly on ambient temperature and variations in output with ambient temperature may be in the order of tenths of a dB (several percent) per degree Celsius. Diode units may also be modulation sensitive, with errors in reading dependent on the form of modulation.

### 5.2.2 Bolometer

In bolometric instruments, the microwave/RF currents cause heating and induce a change in some physical property, most commonly the resistance of a thermistor. A measure of the power density would then be the resulting imbalance of a bridge circuit containing the thermistor. For small deviations from balance, the bridge output is proportional to the temperature of the thermistor and therefore to the square of the electric field, i.e., to the RF power dissipated in the thermistor. The thermistors used have a positive temperature coefficient. Thus, this type of instrument can withstand large overloads without damage. As the power density increases, the resistance of the element increases, causing a mismatch condi-

tion and the power absorbed by the thermistor is also inversely proportional to its resistance. Both effects limit the power absorbed by the element. These units may exhibit drift in the zero reading and loss in sensitivity caused by changes in ambient temperatures.

### **5.2.3 Thermocouple**

The detection elements in thermocouple-type radiation monitors are generally thin-film type thermocouples. The films perform the simultaneous functions of lossy antenna element and temperature detector. The output from the thermocouple is proportional to the square of the electric field and the units are relatively independent of ambient temperature (Bassen et al., 1977). Hot and cold junctions of the thermocouple are in extremely close proximity and very stable. Variation in sensitivity is of the order of 0.1% per °C. The use of small, thin, resistive films provides very broad bandwidth. More detailed discussions of these, and other types of instruments, can be found in Aslan (1972), Bowman (1976), Eggert & Goltz (1976), and Eggert et al. (1979).

## **6. MICROWAVE AND RF ENERGY ABSORPTION IN BIOLOGICAL SYSTEMS**

Electric and magnetic fields are induced within a biological system exposed to microwave or RF energy. To understand the resulting biological effects, it is necessary to determine the induced field strength at various internal points of the system. Knowing the electrical and geometrical characteristics of the irradiated object and the external exposure conditions, it is possible, in principle, to calculate the rate at which energy is absorbed throughout the interior of the irradiated object.

The magnitude of interior and exterior scattered and reflected fields depends on many factors: the frequency and configuration of the incident field; the electrical properties of the various layers (tissues) of which the irradiated system is composed; the shape, the size relative to wavelength, and the relative orientation of the system. Biological systems are usually of complex exterior and interior geometry, and consist of several layers with various electrical properties (complex permittivity). As a result, the internal energy deposition in biological systems will be nonuniform. Depend-

ing on the thermal properties and blood flow of tissues, there can be marked differences in the magnitude and rate of increase in temperature, and thermal gradients can result. A review on the interaction of microwave and RF radiation with living systems has recently been completed by Stuchley (1979).

## 6.1 Methods of Computation

Methods of computation for predicting internal energy deposition using various approximate mathematical models of human and animal bodies have been developed. These show reasonable agreement with experimental measurements of energy absorption in phantom models and animal carcasses (Guy, 1971, 1974; Johnson & Guy, 1972).

Theoretical analyses have led to the prediction of the resonant absorption of energy in both the whole and parts of the body of human models and animals. The effects of such variables as frequency and polarization of the field, the size and shape of the exposed body, and the surrounding environment, ground plane, and other objects have been evaluated.

Details concerning computational and experimental techniques, data on specific absorption rates within the range of 10 kHz—100 GHz in man and laboratory animals, as well as pertinent reference lists, can be found in the three editions of the "Radiofrequency radiation dosimetry handbook" (Johnson et al., 1976; Durney et al., 1978, 1980). In the most recent edition of the Handbook, several models relevant to exposures in the near-field of the radiation source have been included.

The intensity of the internal electric field or the amount of energy absorbed per unit time per unit mass (the specific absorption rate (SAR)) are both used in radio-frequency and microwave dosimetry. Most frequently used units of SAR are W/kg and mW/g. Further discussion on SAR follows in section 6.3.

## 6.2 Experimental Methods

Measurements of internal electric fields within dielectric media are possible if a small, insulated dipole array is used. Such a device has been developed in miniature form and used to measure internal microwave fields in phantoms and living animals with uncertainties of less than 1 dB. The advantage of the implantable electric field probe method over thermal dosimetric techniques is the greater sensitivity of the field probe, allowing the use of microwave and RF sources with much lower power outputs. Thus, the energy deposition can be mapped in a biological body or a scan through a

phantom exposed to only moderate levels of microwave or RF energy.

Thermal measurements in phantoms or animal carcasses can yield direct data on SAR. Small thermistor probes with non-perturbing resistive leads, and optical fibre probes with temperature-sensitive sensors using a light source have been developed (Aslan, 1972; Cetas, 1975; Livingston et al., 1975; Bowman 1976; Deficis & Prou, 1976; Bassen et al., 1977). Thermographic cameras used in conjunction with sectioned phantom models or carcasses can record the heat distribution in an entire plane. High intensity exposure fields have to be employed to yield significant increases in temperature.

### 6.3 Energy Absorption

Biological systems are lossy dielectrics characterized by limited conductivity. The losses originate from the movement of free ions (conduction loss) and molecular rotation (dielectric loss). Thus, electromagnetic waves, propagating through a biological medium, interact with it, and energy transfer occurs. This results in attenuation of the field and an increase in the kinetic energy of the molecules of the medium, i.e., in heating. The degree of attenuation of the field depends on the dielectric properties of the medium, and these change with the frequency of the incident field. The real and imaginary parts of the complex permittivity generally decrease with increasing frequency.

The above statements present, in a simplified form, the classical theory of microwave and RF energy absorption, which was developed by Schwan and his school (Schwan & Piersol, 1954, 1955; Schwan, 1971, 1976). The latest restatement of this approach (Schwan, 1978) may be summarized as follows: "Among the established effects in biological systems the most important is heat development but direct field interactions with membranes, biopolymers, and biological fluids are all possible". All energy deposition, however, takes place because of conduction losses, molecular movements, and biopolymer rotation.

During the last few years, the concept of the specific absorption rate (SAR) has been developed for quantifying microwave and RF effects.

As mentioned earlier, the specific absorption rate is defined as the rate of energy absorption per unit mass of an exposed object. For steady-state sinusoidal fields, the SAR is directly proportional to the tissue conductivity, the square of the electric field, and inversely proportional to the mass density. The relationship is more complex in pulsed or modulated fields, if the intrinsic properties of the medium are non-linear. However, since the SAR is related to the intensity of the internal electric field, this concept can be

used independently of the nature of the interaction mechanism responsible for biological effects. This stems from the fact that it is the internal electric field intensity that quantitatively describes the interaction. Nevertheless, it may not be the only factor, e.g., frequency and/or modulation of the radiation field may strongly affect biological effects. Consequently, the nature of the radiation fields should always be considered in addition to the SAR.

The SAR is a measure of the absorbed energy which may or may not all be dissipated as heat. The temperature is a function of the SAR, but it is also a function of the thermal characteristics of the absorber (i.e., the size, shape, thermal conductivity).

The values of the SAR averaged over the whole body and the distribution of the SAR have been estimated theoretically and measured experimentally in models and experimental animals for various exposure conditions. For human subjects, the average SAR for exposures in the far field may reach a peak in the frequency range of 30—200 MHz, depending on various factors associated with the specific exposure situation (Johnson et al., 1976; Durney et al., 1978, 1980). Fig. 11 presents the average SAR in man and experimental animal models at an incident power density of  $1 \text{ mW/cm}^2$  in free space (far-field) conditions. The graphs in Fig. 11 (page 46) show the importance of size, frequency, and orientation, while Fig. 12 shows values of average SAR at the resonant frequency for several exposure conditions for models of man and 2 sizes of rats. This mathematical modelling is only possible for greatly simplified models.

In addition to the average SAR, the SAR distribution in many models has been calculated. Much of this work can be found in reports by Shapiro et al. (1971), Lin (1976), Gandhi et al. (1979), Kritikos & Schwan (1979), and is summarized in the latest edition of the Dosimetry Handbook (Durney et al., 1980).

In the absence of adequate knowledge concerning the mechanisms of interactions between microwave energy and biological systems, and in the light of the limitations inherent in the SAR, the following conclusions can be drawn:

(a) SAR alone cannot be used for the extrapolation of effects from one biological system to another, or for the extrapolation of biological effects from one frequency to another.

(b) Curves for exposure which produce equivalent SAR for a given body over the microwave/RF energy spectrum may be used to predict equivalent average heating, provided data concerning heat dissipation indicates equivalent heat dissipation dynamics. Such curves cannot, however, be used as the only basis for predicting biological effects or health risks over the microwave/RF spectrum, since from current knowledge, it is not possible to state that

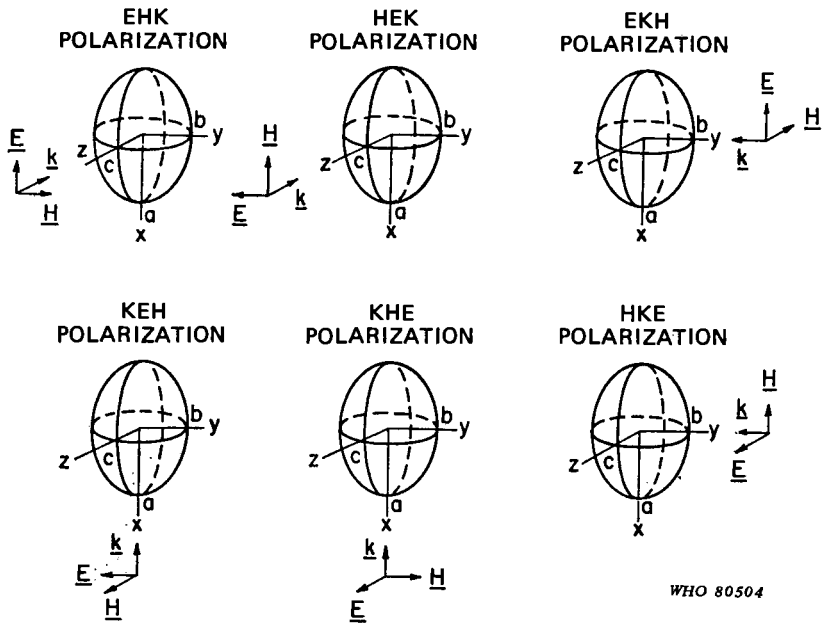

WHO 80504

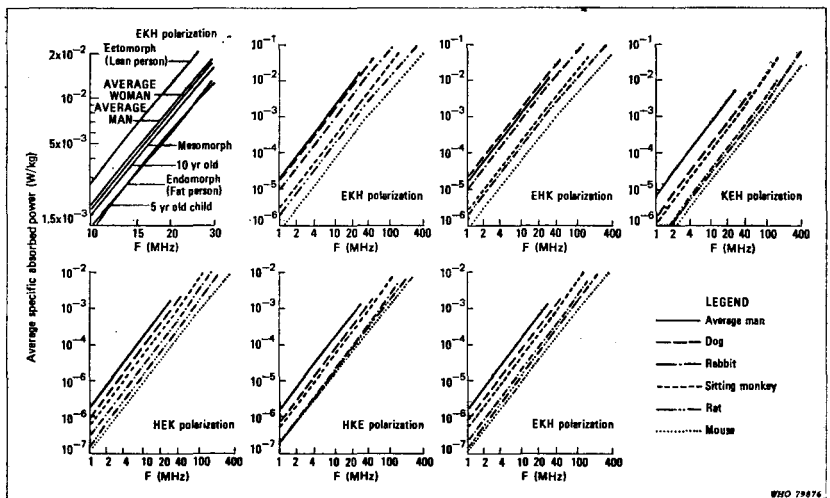

Fig. 11. Average specific absorbed power in ellipsoidal models of man and test animals; incident power density  $1 \text{ mW/cm}^2$  (From: National Health and Welfare, Canada (1977) based on Rowe et al., 1973).



<u>70 kg man</u> <u>(1.75 m height)</u>	<u>100 g rat</u> <u>(11.5 cm length)</u>	<u>400 g rat</u> <u>(18.9 cm length)</u>
--	---	---

I. At resonance for free space.



151 W 2.16 W/kg f = 62-68 MHz	0.8 W 8 W/kg F = 987 MHz	2 W 5 W/kg f = 600 MHz
-------------------------------------	--------------------------------	------------------------------

II. At resonance for conditions of electrical contact with the ground plane.

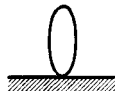

$2 \times 151 = 302$  W  
4.31 W/kg  
f = 31-34 MHz

III. At resonance for placement in front of a flat reflector.

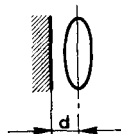

$d = 0.125 \lambda$

$4.7 \times 151 = 710$ W 10.14 W/kg f = 62-68 MHz	3.8 W 38 W/kg f = 87 MHz	9.4 W 23.5 W/kg f = 600 MHz
---	--------------------------------	-----------------------------------

<u>70 kg man</u> <u>(1.75 m height)</u>	<u>100 g rat</u> <u>(11.5 cm length)</u>	<u>400 g rat</u> <u>(18.9 cm length)</u>
--	---	---

IV. At resonance for placement in a  $90^\circ$  corner reflector.

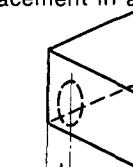

$d = 1.5 \lambda$

$27 \times 151 = 4077$ W 58.24 W/kg f = 62-68 MHz	21.6 W 216 W/kg f = 987 MHz	54 W 135 W/kg f = 600 MHz
---	-----------------------------------	---------------------------------

V. At resonance in electrical contact with ground plane, in front of a flat reflector.

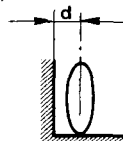

$d = 0.125 \lambda$

$2 \times 710 = 1420$  W  
20.28 W/kg  
f = 31-34 MHz

VI. At resonance in electrical contact with ground plane, in a  $90^\circ$  corner reflector.

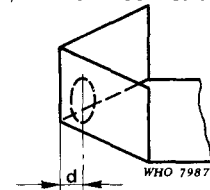

$d = 1.5 \lambda$

$2 \times 4077 = 8154$  W  
116.48 W/kg  
f = 31-34 MHz

Fig. 12. Specific absorption rates for man and two sizes of rat irradiated with the plane wave of a power density of  $10 \text{ mW/cm}^2$  under various conditions (From: National Health and Welfare, Canada (1977) based on Gandhi et al. (1977).

equivalent average energy absorption rate for given radiation frequencies is associated with equivalent biological effects.

## 6.4 Molecular Absorption

Despite the photon energies, some recent theoretical explanations of experimental observations strongly indicate the possibility of interactions at the molecular level. Proton tunnelling, changes in the conformation of molecules, and cooperative mechanisms have been envisaged (Fröhlich, 1968; Illinger, 1971, 1974; Cleary, 1973, 1978; Rabinowitz, 1973; Grodsky, 1975; Keilmann, 1977).

It has been postulated (Fröhlich, 1968; Rabinowitz, 1973) that microwaves in the frequency region of 60—120 GHz may influence macromolecules in biological systems, altering such functions as cell division, and virus inactivation or activation. Effects on enzyme systems, DNA-protein structures (chromosomes), and cell membranes are possible (Grundler & Keilmann, 1978; Pilla, 1979; USSR Academy of Sciences, 1973). Physical experimental techniques need developing and further studies on biological effects are necessary. Similar mechanisms may be operative at lower frequency ranges (Kaczmarek & Adey, 1974; Adey, 1975; Grodsky, 1975; Bawin & Adey, 1976) and the present status of knowledge about the molecular absorption of microwaves and RF in biological systems has been summarized by Straub (1978) who states:

“Absorption of non-ionizing electromagnetic (EM) radiation by biologically important molecules can occur by many different mechanisms over the frequency range from several hertz through the millimeter microwave region. The absorption of EM radiation is determined by the bulk dielectric properties of living tissues, cells and biomolecules in solution. However, the existence of diverse and complex molecular structures characteristic of biological systems makes it necessary to consider the details of absorption and dissipation of EM energy. In addition, the biological function of the molecular species absorbing energy needs to be studied to understand the significance of the EM absorption. Among many possible examples the following five are given: (1) The network of membranous lipid-containing structures within and at the outside limit of cells poses a series of barriers to thermalization of the absorbed radiation. Thus, adiabatic conditions may be maintained in small membrane bound volumes for much longer periods of time than in simple solution. Large thermal gradients and temperature elevations can result. (2) Subsequent temperature elevation may cause membrane structures or complex protein assemblies to pass through phase transitions, altering their properties. (3) Spatial anisotropy in the arrangement of large molecular assemblies, as found in mitochondria and ribosomes, results in specialised functions which can be completely changed if some of the molecules are rotated or translated by EM radiation. (4) Quantum effects such as proton tunnelling with resulting isomerization of DNA base pairs may also be influenced by EM radiation. (5) Otherwise random motion of

“gates” in excitable channels of nerve membranes may be brought into forced oscillation by EM radiation, with resultant membrane depolarization. Detailed knowledge of structure and function of the biological system thus reveals many perturbations which might be induced by EM absorption, and, conversely, EM radiation can be used to probe biological structures and function.”

## 7. BIOLOGICAL EFFECTS IN EXPERIMENTAL ANIMALS

During the past thirty years, research has been devoted to various aspects of the interactions between microwave and radiofrequency radiation and biological materials. Unfortunately, most experiments have tended to report biological effects as phenomena rather than attempting to establish whether such radiation presents a health risk to man and other biota. In Czechoslovakia, Poland, and the USSR, a continuous research effort made over the last 25—30 years has resulted in numerous research reports and reviews (Presman, 1968; Marha et al., 1971; Baranski & Czerski, 1976). In the past 20—25 years, interest in this field of studies has increased in the USA, first with the establishment of the Tri-service Programme in 1956 and then other programmes in later years.

It is impossible to review the numerous studies (see bibliographies by Glazer et al., 1976; Glazer & Brown, 1976; Glazer et al., 1977) related to the biological effects of microwave radiation and only those most pertinent to the evaluation of potential biological hazards have been cited. Potentially beneficial effects of microwave radiation are outside the scope of this document.

Only limited information is available from studies of human subjects directly exposed occupationally or experimentally to microwave radiation. Most of the data on possible harmful effects are based on studies of separate cells, simple organisms, animals, and models, making it difficult to extrapolate such experimental results to man.

Radiant energy absorption in the living system followed by direct interaction with biophysical or biochemical processes, may be defined as the primary interaction. Changes in the structure and function of a biological system as a result of the primary interaction are considered to be biological effects. Immediate biological effects arising at the site of the primary interaction may induce further indirect changes, both acute and chronic.

The analysis of data on effects requires the consideration of a sequence of events: the physical interaction followed by physio-

logical reactions — local and generalized, and immediate and delayed biological effects. In addition, frequent activation of adaptive mechanisms may lead to their exhaustion via the classical sequence of events of stress-adaptation-fatigue. Consequently, the effects of single and repeated exposures should be considered separately, even when exposures take place under identical conditions.

For many years, the primary interaction of microwave and RF radiation with living systems was considered almost exclusively in terms of electromagnetic field theory (Schwan, 1976, 1978). It was concluded that the conversion of the absorbed energy into kinetic energy of molecules (i.e., heat) was the only significant mechanism involved. However, there are discrepancies between some empirical observations and the theoretical explanations available (Cleary, 1973; Baranski & Czerski, 1976; Dodge & Glaser, 1977), which indicate that "non-thermal" effects may play some role. Direct interference with bioelectric phenomena (as seen on the electroencephalogram and the electromyogram) and the role of electromagnetic fields in the transmission of biological information was suggested by Presman (1968), but these hypotheses need experimental verification.

Interaction of microwave energy at the molecular level has been postulated to explain the primary interaction between microwaves and parts of living systems such as membranes (Fröhlich, 1968; Adey, 1975; Bawin et al., 1975; Grodsky, 1975; Bawin & Adey, 1976; Grundler & Keilman, 1978; Pilla, 1979).

## **7.1 Hyperthermia and Gross Thermal Effects**

Numerous biological and pathophysiological effects have been attributed to temperature increases in the tissue resulting from absorption of microwave energy. Thermal effects leading to gross injury or death have been studied in a number of experimental animals and are described here. More subtle effects of thermal origin, caused by absorption of microwave energy will be described in later sections.

The absorption of microwave energy often results in an increase in temperature. If the rate of increase exceeds the ability of the thermoregulatory system of the organism to dissipate heat, hyperthermia will occur, followed by injuries such as burns, haemorrhage, tissue necrosis (Cleary, 1978), and death. The extent of the damage depends on the thermal sensitivity of the tissue. With partial body exposure, highly vascularized tissues show greater resistance to thermal damage, because of the more efficient heat dissipation. Microwave-induced death in an experimental animal depends not only on the quantity of absorbed energy but also on the rate

of absorption, the animals thermoregulatory system, its physiological status, and the environment. Quite different responses to microwave exposure have been observed in various species. Table 10

Table 10. Power densities and exposure times until thermal death in a number of animal species at various frequencies<sup>a</sup>

Species	Power density mW/cm <sup>2</sup>	Exposure time min	Frequency MHz	Rectal temperature increase °C	Reference
dog	350	15	200	5	Addington et al. (1956)
	330	15	200	4	Michaelson (1971)
	220	21	200	4	Addington et al. (1956)
	165	270	22 800	4-6	Ely & Goldman (1956)
rabbit	300	25	2 800	6-7.5	Ely & Goldman (1956)
	165	40	2 800	> 4	Michaelson (1971)
	165	30	200	6-7	Ely et al. (1954)
	100	103	3 000	4-5	Gordon (1966)
rat	400	13-14	10 000	7	Gordon (1966)
	300	15	3 000	8-10	Gordon (1966)
	300	15	24 000	5	Ely & Goldman (1956)
	150	15	2 400	—	Michaelson (1971)
	100	25	3 000	6-7	Gordon (1966)
	100	5-120	mm-dm	—	Gordon (1966)
	80	35	2 400	—	Michaelson (1971)
	80	56	24 000	—	Deichmann (1966)
	50	80	24 000	—	Deichmann (1966)
	40	90	3 000	7	Gordon (1966)
	40	30-180	mm-dm	—	Gordon (1966)
	30	135	24 000	—	Deichmann (1966)
	10	> 5 h	mm-dm	—	Gordon (1966)
mouse	180	3	24 000	—	Deichmann (1966)
	150	5	24 000	—	Michaelson (1971)
	80	13	24 000	—	Deichmann (1966)
	80	13	24 000	—	Michaelson (1971)
	50	35	24 000	—	Deichmann (1966)
	50	35	24 000	—	Michaelson (1971)
	30	140	24 000	—	Deichmann (1966)

<sup>a</sup> Adapted from: Baranski & Czernski (1976).

gives the survival times of various experimental animals following prolonged continuous exposure to microwaves at different frequencies.

Dogs exposed to microwaves at frequencies of 2.86 GHz, 1.28 GHz, and 200 MHz (Michaelson, 1971, 1973) and a power density of 165 mW/cm<sup>2</sup> experienced three distinct phases of hyperthermia. First, the body temperature increased by 1-1.4 °C after about 30 min (the extent of the delay depending on the exposure frequency). Second, at thermal equilibrium which lasted about 1 h (longer at lower frequencies), the rectal temperature stabilized at between 40.5 °C and 41 °C. Finally, the thermoregulatory system could not dissipate the heat rapidly enough, the rectal temperature quickly rose above 41 °C, and the animal succumbed. Similar thermal responses have been described for dogs with body weights between

4 and 20 kg. No period of thermal equilibrium was observed in rats and rabbits exposed at the same power density (165 mW/cm<sup>2</sup>) (Michaelson, 1973).

Table 11 gives the survival time of rats exposed intermittently to 24 000 MHz microwaves at 300 mW/cm<sup>2</sup>. These data provide information on a situation corresponding to exposure to a rotating antenna. This type of intermittent exposure prolongs the survival time of the irradiated animals.

Table 11. Survival time of rats following intermittent exposure to 24 000 MHz microwaves at 300 mW/cm<sup>2</sup> depending on the relationship between duration of exposure period and duration of exposures on-off<sup>a</sup>

Operation period of the transmitter (s)		Survival time equal to effective irradiation time (min)
on	off	
60	60	16.5
5	15	28
3	3	40
30	60	39
10	20	65
3	6	95
60	180	28
10	30	76
3	9	110 to 120
30	120	70 to 75
15	60	Over 100

<sup>a</sup> From: Baranski & Czernski (1976) based on Deichmann et al. (1959).

Table 12 provides a summary of data (Baranski & Czernski, 1976) on the mass, body surface, and basal metabolic rate of commonly used experimental animals. These data can be used to compare the experimental results of a microwave-induced thermal load with the animal's ability to dissipate heat (its thermoregulatory system).

Table 12. Mass, body surface and metabolic rate in various experimental animals<sup>a</sup>

	Man	Dog	Rabbit	Monkey	Guineapig	Rat	Mouse
Mass (kg)	65	15.0	3.5	3.2	0.8	0.2	0.02
Body surface (m <sup>2</sup> )	1.83	0.65	0.2	0.26	0.071	0.081	0.005
Basal metabolic rate (W/m <sup>2</sup> )	45.5	46.0	40.5	30.5	33.7	45.2	26.2

<sup>a</sup> From: Baranski & Czernski (1976).

In the results presented in Table 10, it was generally assumed that the area of the species exposed was approximately one third of the body surface, the incident energy was totally absorbed, the

heat dissipation index was  $12 \text{ W/m}^2/\text{°C}$ , and that the initial temperature difference between body surface and surrounding air was  $10 \text{ °C}$ .

Environmental conditions can influence the thermal response (Baranski et al., 1963; Michaelson, 1971). At an ambient temperature above normal ( $40.5 \text{ °C}$ ), the animal's thermoregulatory system can maintain a normal body temperature, but is not able to cope with an additional thermal load produced by microwave exposure. However, at a lower ambient temperature ( $11 \text{ °C}$ ), after an initial period of adaptation, the microwave radiation does not significantly affect the animal's rectal temperature (Michaelson, 1973).

The influence of environmental conditions on hyperthermia induced by microwave radiation exposure can be summarized as follows: (a) increasing ambient temperatures and humidity enhance thermal stress; and (b) increased air velocity decreases thermal stress.

In a study by McLees & Finch (1973) in which rats were exposed to  $24 \text{ GHz}$  and  $300 \text{ mW/cm}^2$ , it was shown that body cover also affected hyperthermia. Animals with and without hair died within 15.5 and 18.5 minutes, respectively, indicating that clothing could be expected to enhance the thermal effects of radiation, unless such clothing shielded from, or reflected microwave energy.

When dogs were anaesthetized using sodium pentobarbital, chlorpromazine, or morphine, impaired thermoregulatory responses and increased susceptibility to radiation thermal stress were observed (McLees & Finch, 1973; Baranski & Czernski, 1976).

Repeated exposure resulted in physiological adaptation via the classical sequence of stress-adaptation-fatigue. Daily exposure of dogs to  $1280 \text{ MHz}$  microwaves for 6 h per day, 5 days per week, for one month at a power density of  $100 \text{ mW/cm}^2$ , resulted in an increase in rectal temperature with each exposure during the first week. During the following 3 weeks, temperature increases were moderate, and a progressive reduction in the pre-exposure temperature was observed as the number of exposures increased (Michaelson, 1973). These results have been confirmed for other species (Gordon, 1966; Phillips et al., 1973).

The blood circulation was considered to be an effective system for distribution of the heat generated throughout the body (Michaelson, 1971), and until recently, the thermal effects of microwaves in animals were mainly considered in terms of "volume heating". Guy and his associates (Guy, 1971, 1974; Johnson & Guy, 1972) using phantom models, developed elegant thermographic techniques and demonstrated convincingly very nonuniform deposition of microwave energy, expected to result in nonuniform deep body heating. In physiological terms, this means that absorbed energy may cause local thermal stimulation or gross effects on different organs depending on the exposure level.

## 7.2 Effects on the Eye

Studies on the effects of microwave radiation on the eye were carried out as early as 1948 (Richardson et al., 1978). Most animal studies have been conducted on the New Zealand white rabbit because its eye is similar to the human eye.

Investigations to determine cataractogenic radiation levels and lengths of exposure at various frequencies have been conducted in both the far and near fields. In far-field studies, the whole of the body of the animal is exposed but, in some cases, this results in the animal's death. Near-field techniques involve exposing the eye at some distance from the source and permitting air to circulate against the eye, or exposing the eye by direct contact with a source of microwave energy, so that there is no air circulation. The conditions of exposure have a considerable influence not only on the development of cataracts but also on their location in the eye. When air circulation is permitted, the exposure causes opacities to develop in the posterior subcapsular cortex of the lens. Without an air gap, opacities develop in the anterior subcapsular cortex (Carpenter et al., 1974b).

Guy and his colleagues (1975b) have recently determined threshold power density levels and durations of exposure for cataract formation in rabbit eyes with a single exposure to 2.45 GHz near-field radiation. Their results are in good agreement with earlier data obtained by Carpenter and his co-workers (1974b) as shown in Fig. 13. At 2.45 GHz, the maximum temperatures occurred near the posterior surface of the lens, and irreversible changes in the lens took place in the posterior cortical area only. Other changes in the exposed eye were found to be transient in nature and disappeared within two days of irradiation. The minimum power density level at which cataracts were formed appeared to be  $150 \text{ mW/cm}^2$  for 100 min corresponding to a maximum specific absorption rate in the vitreous body of  $138 \text{ W/kg}$ . The threshold temperature in the eye for cataract formation was estimated to be about  $41^\circ\text{C}$  (Guy et al., 1975b).

To investigate the mechanism by which microwaves produce cataracts at 2.45 GHz, rabbits were subjected to general hyperthermia and local heating of the lens (Kramer et al., 1976). Rabbits, under general hyperthermia, were kept at a temperature above  $43^\circ\text{C}$  for 35 minutes. After 4—6 months, the only cataracts observed occurred in eyes damaged by insertion of the temperature probes. The authors concluded that basic differences occur when heating by means of microwave energy and by convective hyperthermia. Eyes irradiated with microwaves show a characteristic temperature gradient, with the highest temperature behind the lens, whereas in hot bath experiments, the highest temperature occurs at the surface of the cornea. Further high-level microwave exposure raises



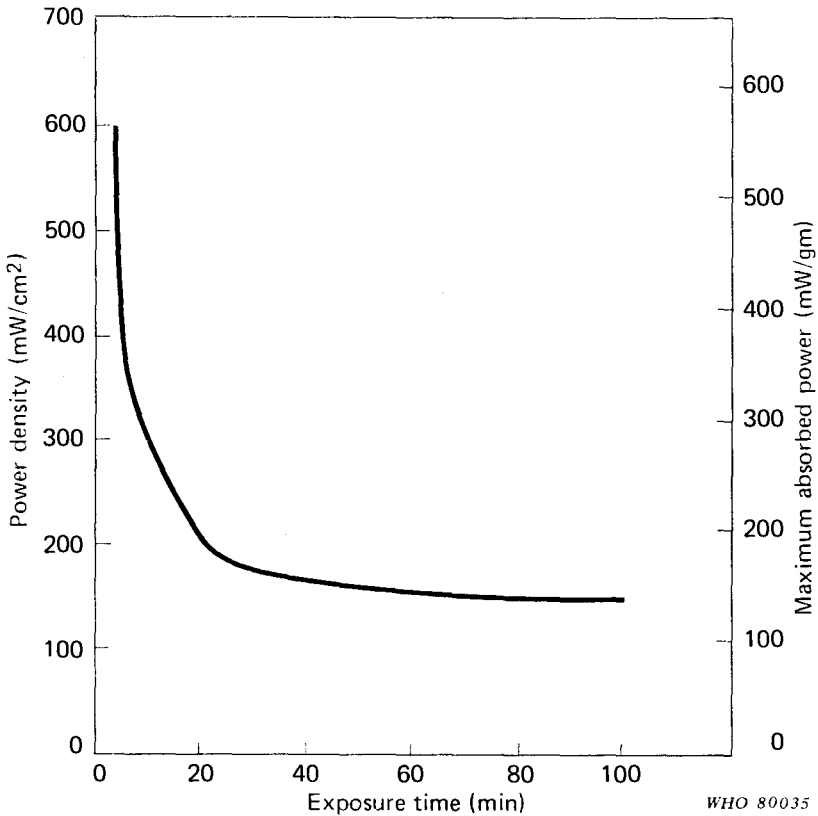

Fig. 13. Threshold time and microwave power density levels for the production of cataracts in rabbits' eyes by single exposures to near-field 2.45 GHz radiation. From: Guy et al. (1975b).

the eye temperature within minutes, compared with at least 2 h in the hot water bath. Thus, a sharp temperature gradient and a high rate of heating rather than gradual, more uniform heating may be necessary to produce cataracts (Kramer et al., 1976).

In studies to investigate the relative cataractogenic effects of exposure to two frequencies, 2.45 and 10 GHz, a special dielectric lens was used to irradiate the eyes of New Zealand white rabbits, selectively. With a constant power density, exposure to 10 GHz induced a higher intraocular temperature than exposure to 2.45 GHz. However, when the animals were exposed to these frequencies for the same length of time, cataracts were induced at lower power densities at 2.45 GHz than at 10 GHz (Table 13). Although opacities formed in the posterior subcapsular cortex of the lens at both frequencies, their

Table 13. Production of cataracts in the eyes of rabbits by a single 30-min exposure to 2.45 GHz or 10 GHz

Incident power density (mW/cm <sup>2</sup> )	2.45 GHz		10 GHz	
	Number of experiments	Development of lens opacities (%)	Number of experiments	Development of lens opacities (%)
275	12	8	—	—
295	12	67	—	—
310	12	58	12	0
325	12	100	—	—
345	2	100	12	50
375	—	—	12	67
410	—	—	11	82
440	—	—	2	100

° From: Hagan & Carpenter (1976).

initial appearance and subsequent development differed. Radiation at 2.45 GHz induced posterior cortical banding within 1 or 2 days, followed by the appearance of small granules along or on the horizontal line of the posterior suture. Occasionally small vesicles developed. Some opacities also had a fibrillar, cotton-like appearance, and superficial damage, such as pupillary constriction and hyperaemia of the bulbar and palpebral conjunctiva was observed within 24 hours (Hagan & Carpenter, 1976).

In one of the very few investigations of chronic, low-level exposure of rabbits' eyes (2 mW/cm<sup>2</sup> for 8 h per day, 5 days a week, for 8—17 weeks at 2.45 GHz), ocular changes were not observed up to 3 months after termination of exposure (Ferri & Hagan, 1976).

When the cataractogenic power density levels for continuous wave and pulsed radiation were compared at a few frequencies, no differences in the threshold levels for cataractogenesis were found (Carpenter & Van Ummersen (1968); Carpenter (1969); Birenbaum et al. (1969); Williams & Finch (1974); Weiter et al. (1975). The average power density, not the peak power density, appears to be the critical field parameter in cataract induction.

Most authors including Belova (1960), Carpenter et al. (1974b), Paulson (1976), Kramer et al. (1978) and Steward-Dehaan et al. (1979) have tended to relate microwave cataracts to the secondary effects of local temperature increase. The conventional view is that, as the crystalline lens does not have its own blood supply, it is easily overheated with consequent damage to capsular cells and denaturation of the protein in the lens.

Studies have been performed to determine if cataracts can be formed by an accumulation of exposures at subthreshold levels. In one experiment, rabbits' eyes were exposed for 3 min to 2.45 GHz radiation at a power density of 280 mW/cm<sup>2</sup> (5 min exposure was required to induce a cataract after a single exposure). When the 3-min exposure was given once a day for 5 days, the animals developed cataracts. However, if the eyes were exposed under the same

conditions, but with a break of 7 days between exposures, cataracts did not develop (Carpenter, 1969). In an earlier study, rabbits' eyes were exposed to 2.45 GHz at a power density of 80 mW/cm<sup>2</sup> for 60 min daily, for 10 or 15 days (Carpenter & Van Ummersen, 1968). Cataracts appeared 1—6 days after treatment. However, the authors later indicated that the power density measurement was inaccurate and that subsequent measurements showed that the actual power density was greater than 80 mW/cm<sup>2</sup>.

Paulsson et al. (1979) studied the eyes of rabbits exposed to 3.1 GHz pulsed (pulse length 1.4  $\mu$ s, repetition frequency 300 Hz) radiation at an average intensity of 55 mW/cm<sup>2</sup> (1.3 MW/m<sup>2</sup> peak) either to single exposures of 1—1 1/2 h or, after a series of repeated 1-h exposures, for up to 53 h during 100 days. Degenerative changes in the retinal neurons and synaptic boutons, and reactive changes in glial cells were observed only following the repeated exposures. No evidence was found of increased permeability of the blood-retina barrier.

Effects of millimetre waves (35 and 107 GHz) at power densities ranging from 5 to 60 mW/cm<sup>2</sup> for 15 min—1 h were investigated in rabbit eyes by Rosenthal et al. (1976). Corneal damage and epithelial and stromal injury were observed. Stromal injury appeared at lower power densities (5 mW/cm<sup>2</sup>) at a frequency of 107 GHz than at 35 GHz, but it was concluded that keratitis (inflammation of the cornea) was a useful criterion for ocular response to millimetre radiation. Keratitis occurred at lower power densities than those required to produce other ocular effects such as iritis or lenticular injury. The recovery rate from stromal injury depended on the frequency of the radiation and was faster after exposure to 107 GHz.

The following conclusions on the effects of microwave radiation on the eye can be drawn from these and other data from literature reviews:

(a) Above 500 MHz, opacities of the eye may be produced when power densities exceed 150 mW/cm<sup>2</sup>, if the duration of exposure is sufficiently long;

(b) Although ocular injury has not been reported at frequencies below 500 MHz, its possibility cannot be excluded;

(c) The frequency of the microwave radiation influences the type and location of the injury to the eye;

(d) Exposure conditions, namely whether in the near field or far field, whole body or selective exposure of the eye, eye exposure with or without an air gap (to provide cooling), and the temperature of the animal's body, all influence the power density and duration of exposure needed to produce eye injury.

(c) Injury to the eye from microwaves appears to be predominantly thermal in nature, temperature gradients within the eye and the rate of heating being two major factors in the stress that leads to injury. Non-thermal effects cannot be excluded but they alone

do not appear to be sufficient to produce effects in the eye, although they may provide a necessary mechanism of interaction.

(f) As can be seen in Fig. 13 (p. 55) the threshold curve of power densities versus time to produce eye cataracts is not linear. Exposure of the eye at each frequency seems to require a threshold microwave power density below which even continuous exposure does not produce eye injury. This would appear to exclude the possibility of cataractogenesis caused by low level chronic exposure, and this was confirmed in a recent experiment (Ferri & Hagan, 1976).

(g) Pulsed and continuous wave radiation with the same average power density level seem to possess the same potential for cataract induction. However, effects from pulsed radiation with a small duty factor and high peak power cannot yet be excluded;

(h) Cataracts can be produced by repeated exposures to sub-threshold power density levels. For this cumulative effect to occur, the levels have to be sufficiently high that a slight but persistent injury is not fully repaired before another exposure takes place. However, if the time between exposures is sufficiently long for repair to take place, cumulative damage is not observed.

### 7.3 Neuroendocrine Effects

Interaction between the endocrine and nervous systems is very important to the functioning of the human body. The hypothalamus within the brain is a control centre involved in the regulation of the autonomic nervous system, including such visceral functions as temperature control within the whole body. This gland, coordinated by the central nervous system (CNS), releases specific factors into the pituitary portal system, which regulate hormones released by the endocrine organs. The endocrine system can be considered as a feedback control system where the hypothalamus, via the pituitary, causes hormones to be secreted by endocrine glands. Once the endocrine hormones have reached a certain level, this information is fed back to the pituitary and hypothalamus, causing a reduction or cessation in hormone secretion. The system's actions are modified by direct neural inputs from higher brain centres and peripheral nerves.

Descriptions of the biochemical and neuroendocrine aspects of exposure to microwaves can be found in recent reviews by Michaelson et al. (1975) and Cleary (1977).

Dogs exposed to 3 GHz microwaves at 10 mW/cm<sup>2</sup> showed a substantial increase (100%—150%) in corticosteroid levels, a decrease in blood potassium, and an increase in blood sodium content (Petrov & Syngajevskaja, 1970). The increase in the corticosteroid levels during and after irradiation may have been an adaptive reaction, since in some animals the adrenocortical function becomes

inhibited and sensitivity to microwave radiation increases because of insufficient release of adrenocorticotrophic hormone (ACTH).

Dumanskij & Sandala (1974) found that chronic low-level exposure of rats and rabbits to 3 cm, 12 cm, and 6 m microwaves at  $10 \mu\text{W}/\text{cm}^2$  and below, for 8–12 h per day, for 120 days, reduced cholinesterase and increased 17-ketosteroid levels in the urine during the 60 days following irradiation. A reduced amount of ascorbic acid in the adrenal glands and reduced adrenal gland weight were also observed. Syngajevskaja et al. (1962) exposed dogs and rabbits (162 animals) to decimeter waves at  $70 \text{ mW}/\text{cm}^2$  for 30 min and reported increases in the ascorbic acid concentration in the adrenals, while exposure at  $5 \text{ mW}/\text{cm}^2$  for 30 min caused it to decrease. Changes in glucose levels in the blood and variations in liver glycogen content were observed; lactic acid levels were also affected. It has been suggested that a whole body rise in temperature caused by microwave exposure suppresses the hormone-producing functions of the anterior pituitary and adrenals, while exposures not resulting in an increased rectal temperature enhance hormone production (Petrov & Syngajevskaja, 1970).

No significant alterations were observed in growth hormone or thyroxine levels in barbiturate-anaesthetized dogs, cranially exposed to 2.45 GHz microwaves at various power densities ( $20\text{--}80 \text{ mW}/\text{cm}^2$ ) for 1 h (Michaelson et al., 1975). When rats were exposed (whole body) for 1 h to 2.45 GHz microwaves at  $9 \text{ mW}/\text{cm}^2$  an increase in growth hormones was observed, but at  $36 \text{ mW}/\text{cm}^2$  exposure, a significant decrease was noted (Syngajevskaja et al., 1962).

The thyroid activity in rats exposed to 2.45 GHz microwaves at  $1 \text{ mW}/\text{cm}^2$  for 8 h per day for 8 weeks was studied by Milroy & Michaelson (1972). No structural or functional changes were detected, other than those that could be attributed to microwave-induced thermal stress. In contrast, Baranski et al. (1973) reported that rabbits exposed to 10 cm microwaves at  $5 \text{ mW}/\text{cm}^2$  showed increased thyroid activity. Mikolajczyk (1977) suggested that these differences in results were due to the experimental procedure and conditions rather than the differences in species.

When rats were exposed to 2.45 GHz microwaves at 10, 15, 20, and  $25 \text{ mW}/\text{cm}^2$  for 4, 16, and 60 h (i.e., 64 h with two 2-h breaks), Parker (1973) found that the iodine-concentrating ability of the thyroid serum, protein-bound iodine levels, and thyroxine increased slightly at  $10 \text{ mW}/\text{cm}^2$ , but decreased at 20 and  $25 \text{ mW}/\text{cm}^2$  during the 16-h exposure. Exposure at  $15 \text{ mW}/\text{cm}^2$  for 60 h resulted in a decrease in protein-bound iodine and thyroxine, and a decrease in the ability to concentrate iodine.

When male rats were exposed to 2.87 GHz radiation at  $10 \text{ mW}/\text{cm}^2$  for 6 h per day, 6 days per week for 6 weeks, there were no significant differences between the average body and organ weights of irradiated and control animals (Mikolajczyk, 1977). Although

the levels of growth hormone in the anterior pituitary were the same in both groups of rats, a significantly higher level of luteinizing hormone (LH) was found in the irradiated animals. It was suggested that changes in the LH activity might be due to the influence of microwave exposure on the pituitary, or on hypothalamic function or on both.

Various animal studies in which neuroendocrine effects have been reported following exposure to low intensity fields are summarized in Table 14. Baranski & Czernski (1976) state in their

Table 14. Neuroendocrine effects of exposure to low intensity fields<sup>a</sup>

Independent variables	Dependent variables	Experimental subject	Results and comments	Reference
10 cm, cw; 0.01, 1, 3, 10, 20 & 150 mW/cm <sup>2</sup> ; 1 h/day, single or repeated exposures	endocrine gland hormone levels	rats ( <i>in vivo</i> )	Increase in gonadotrophic hormones followed by decrease 18 h after exposure at 10 mW/cm <sup>2</sup> or greater intensities; alteration in hypothalamic function governing the follicle-stimulating hormone (FSH) and luteinizing hormone (LH) release from pituitary; no changes in corticosteroid content of adrenals or blood at 10 mW/cm <sup>2</sup> for 15, 30, or 60 min.	Mikolajczyk (1972)
10 cm, cw; 100 mW/cm <sup>2</sup> 10 min exposure/ day for 14 days	adrenal alterations	rats ( <i>in vivo</i> )	Initial decrease in Sudan III stain-positive lipids, birefringent substances, & ascorbic acid; increase in all variables during course of exposure; return to normal 2 weeks after exposure.	Leites & Skuričina (1961)
decimetre waves, 40 mW/cm <sup>2</sup> ; 1-h daily exposure, prolonged duration.	adrenal cortex alterations, serum electrolytes	rats ( <i>in vivo</i> )	No effect on serum Na <sup>+</sup> or K <sup>+</sup> ; increase in Ca <sup>+2</sup> and C <sup>-1</sup> in serum and urine.	Nikogosjan (1962)
15 mW/cm <sup>2</sup> ; 60 h up to 60 mW/cm <sup>2</sup> ; up to 2 h	neuroendocrine responses	rats ( <i>in vivo</i> )	Transient changes in plasma corticosterone, growth hormone, and thyroid hormone levels (20–30 mW/cm <sup>2</sup> seemed to be the transitional range for stimulation of pituitary — adrenal activation); noted effects correlated with temperature increases in endocrine gland.	Michaelson et al. (1977) and Lotz & Michaelson (1978)
2.45 GHz, cw; 1 mW/cm <sup>2</sup> ; continuous exposure, 8 wk; 10 mW/cm <sup>2</sup> , 8 h/ day for 8 wk	thyroid function	rats ( <i>in vivo</i> )	No structural or functional changes other than those attributable to thermal stress.	Milroy & Michaelson (1972)

Table 14 (contd).

Independent variables	Dependent variables	Experimental subject	Results and comments	Reference
2.45 GHz, cw; 15 mW/cm <sup>2</sup> 60 h exposure	thyroid function	rats ( <i>in vivo</i> )	23 % decrease in protein-bound iodine and 55 % decrease in serum thyroxine.	Parker (1973)
2.86—2.88 GHz, cw; 10—120 mW/cm <sup>2</sup>	survival time, endo- crine function	rats ( <i>in vivo</i> )	Survival time of hypophysectomized rats increased at 120 mW/cm <sup>2</sup> ; 2-week habituation before ex- posure alterations in corticosterone levels; daily exposures at 10 mW/cm <sup>2</sup> for 1 month did not alter gonadotropins (LH and FSH) but single exposures induced detectable alterations.	Mikolajczyk (1974)
10 cm, cw; 5 mW/cm <sup>2</sup> (free field exposure)	carbohydrate metabolism, skeletal muscle me- tabolism	rabbits ( <i>in vivo</i> )	Changes in serum pyruvic and lactic acid; decrease in skeletal muscle gly- cogen; altered elec- tromyography indica- tive of changes in muscle metabolism; altered carbohydrate metabolism.	Baranski et al. (1967)
10 cm, cw; 5 mW/cm <sup>2</sup> , re- peated exposure	thyroid function	rabbits ( <i>in vivo</i> )	Increased radioiodine uptake, histological & electronmicroscopic signs of thyroid hy- perfunction.	Baranski et al. (1973)
10 cm, cw; 50—60 mW/cm <sup>2</sup> , 4 h/day	adrenal function	rabbits ( <i>in vivo</i> )	Decrease 17-hydroxy- corticosteroid in urine, first 20 expo- sures; return to nor- mal at day 10 due to adaptation; no changes in 17-hydro- xycorticosteroid in urine.	Lenko et al. (1966)
metre & decimetre waves; 70 mW/ cm <sup>2</sup> ; 30 min	endocrine function	dogs, rabbits ( <i>in vivo</i> )	Increased adrenal ascorbic acid concen- tration following 70 mW/cm <sup>2</sup> , decrease fol- lowing 5 mW/cm <sup>2</sup> , thermal intensities suppress pituitary & adrenal functions; low-intensity exposure stimulates.	Syngajevskaja et al. (1962)
1.24 GHz, pw; 360 Hz pulse repetition rate; 2 ms pulse, 50 mW/cm <sup>2</sup> ; average power; 6 h/day for 6 days	thyroid al- terations	dogs ( <i>in vivo</i> )	Increased radioiodine uptake 4—25 days after exposure: radio- iodine uptake in- creased 3—4 years after single 100 mW/ cm <sup>2</sup> exposure to 1.28 GHz, pw.	Howland & Michaelson (1959)
2.45 GHz, cw; 20—40 mW/cm <sup>2</sup> ; 2 h	neuroendo- crine re- sponses	dogs ( <i>in vivo</i> )	Transient increased mean plasma corticosterone levels, correlated with mean colonic temperature.	Michaelson et al. (1977b)

<sup>a</sup> Adapted from: Cleary (1978).

review of endocrine effects that it is extremely difficult to sum up the evidence. All aspects of microwave interactions reported need further investigation concerning both the cause and dose dependence of the effects described and the mechanisms involved. However, it could be stated that:

(a) Microwave radiation induces endocrinological changes that may be due to stimulation of the hypothalamic-hypophyseal system, through thermal interaction at the hypothalamus, or immediately adjacent levels of organization, the pituitary, the particular endocrine gland, or the end-organ.

(b) Since the neuroendocrine system is homeostatic, transient neuroendocrinological changes should not be equated with pathological alterations.

(c) Sufficient data are available to indicate that the response of the neuroendocrine system to microwaves depends on the frequency, power density, the duration of exposure, and the part of the body exposed.

(d) The nonuniform distribution of microwave energy within the body seems to be an important factor affecting the response of the neuroendocrine system.

(e) Several components of the neuroendocrine system are critically sensitive to environmental temperature, thus low-power density, microwave-induced effects could result from sensitivity to small changes in temperature.

(f) From available data, it would seem that direct interaction of microwaves with components of the neuroendocrine system cannot be excluded.

#### **7.4 Nervous System and Behavioural Effects**

Microwave radiation effects on the central nervous system and behaviour have been the subject of most controversy in the whole field of bioeffects. Czechoslovak, Polish, and Soviet investigations on this subject commenced in the early fifties and have been the source of most of the reports on the effects of microwaves on man. Animal studies and clinical and industrial surveys in Czechoslovakia, Poland, and the USSR have been summarized by Marha et al. (1971), Baranski & Czernski (1976), and Presman (1968), respectively. The basic assertion is that exposure to microwaves at low power densities results in neurasthenic disorders in man. Subjective complaints such as headache, fatigue, weakness, dizziness, moodiness, confusion, and nocturnal insomnia have been reported. In small experimental animals, chronic and repeated exposures at incident power densities of 10 mW/cm<sup>2</sup> or less have been reported to lead to disturbances in conditioned reflexes and to behavioural changes (Kholodov, 1966; Presman, 1968; Petrov et al., 1970; Frey, 1971, 1977;



Marha, 1971; Lobonova, 1974; Galoway, 1975; Hunt et al., 1975; Serdjuk, 1977; Cleary, 1978). Studies of microwave/RF exposure effects on conditioned and normal reflexes, as well as on behaviour, were carried out on mice, rats, guineapigs, rabbits, dogs, monkeys and in some instances on birds (Romero-Sierra et al., 1974; Bigudel-Blanco et al., 1975; Bliss & Heppner, 1977).

Numerous reports of the sensitivity of the human CNS to low level microwave exposure have stimulated interest in the subject with a consequent increase in studies on microwave effects on the animal CNS (Cleary, 1977). Investigations have been conducted at various levels of CNS organization and range from studies of isolated nerves (McRee & Wachtel, 1977) to behavioural studies in primates (De Lorge, 1976, 1979). These studies were established to determine if the effects were thermally-induced or were the result of the direct action of microwave-energy on the CNS. The results of many studies can be explained by the nonuniform distribution of thermal energy and/or thermal gradients, but the results of others such as the increase in calcium efflux from cerebral tissue, due to specific amplitude modulation are difficult to explain on the basis of heating.

Disturbances in the bioelectric function of the chick forebrain with calcium efflux were observed following *in vivo* exposure to 147 MHz radiation, amplitude modulated at 9—20 Hz (Bawin et al., 1975). These effects could not be obtained when the frequency of amplitude modulation was between 6 and 9 Hz or between 20 and 35 Hz. A 20% increase in calcium was also observed by Kaczmarek & Adey (1974) in the cat brain after *in vivo* exposure to 10 ms pulsed radiation at 200 Hz, 20—50 mV/cm<sup>2</sup>. Further research is needed since these effects may depend on a direct interaction of electromagnetic fields with the cellular membrane (Grotsky, 1975; Straub, 1978; Kolmitkin et al., 1979).

Blackman et al. (1979) recently confirmed the work of Bawin and Adey and their coworkers, in finding that calcium efflux from brain tissue depended on amplitude modulation frequency and power levels. Increased calcium efflux appeared at amplitude modulation frequencies around 9 Hz, peaked from 11—16 Hz, and disappeared above 20 Hz as shown in Fig. 14. It can be said that a "frequency window" exists for this phenomenon. Calcium efflux appears at 0.5 mW/g, reaches higher values at 0.75 mW/g and decreases at 1.0 mW/g. Thus, it can be said that "power windows" also exist. These may shift with frequency (Blackman et al., 1979).

The electrical activity of the brain, measured by means of an EEG, may be influenced by a wide variety of exposure regimes. Acute single exposures to 40 mW/cm<sup>2</sup> or more, induce transient changes in EEG patterns. Early experimentation in this area has been summed up by Kholodov (1966). Long-term, repeated exposures of dogs, cats, rabbits, rats, frogs, and mice at power densities

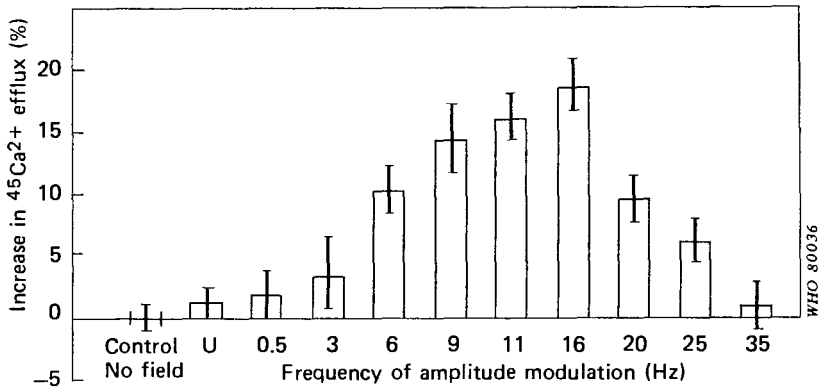

Fig. 14. Effects of amplitude modulated radiofrequency fields (147 MHz) on calcium efflux from isolated forebrain of neonatal chick (From: Bawin et al. (1975).

between 2 and 5 mW/cm<sup>2</sup> were reported to lead to alterations, such as the desynchronization of basal rhythms and later a flattening in EEG tracings (Baranski & Edelwejn, 1968; Bychkov & Dronov, 1974; Bychkov et al., 1974; Gillard et al., 1976). However, these earlier reported effects are questionable since experiments were carried out using EEG electrodes or wires that significantly perturbed the field.

Mice, rats, and rabbits subjected to long-term, low or medium-level (about 1–5 mW/cm<sup>2</sup>) exposure were reported to show an increased susceptibility to convulsant drugs (Baranski & Edelwejn, 1968; Servantie et al., 1974, 1975; Krupp, 1977). Detailed analyses of EEG data and results of pharmacological studies indicate that the reticular formation of the midbrain is the structure in which exposure to microwaves and RF may induce effects at low incident power density levels.

The mechanism of changed susceptibility to drugs acting on the nervous system, particularly convulsant drugs, after repeated microwave exposures is unclear. On the other hand, as the action of many drugs is well understood, the phenomenon may serve to clarify mechanisms of action of microwave and RF radiation on the nervous system (Czerski, 1975). The phenomenon has practical implications in the case of the medication of microwave workers.

Structural changes in the nervous tissue of rabbits and hamsters which were demonstrable by electron and light microscopy, were reported following single exposures to 2450 MHz microwaves at power densities of 25–50 mW/cm<sup>2</sup> (Baranski, 1967; Baranski & Edelwejn, 1979; Albert & De Santis, 1975; Albert, 1979). In their study on rabbits subjected to single or repeated exposures to continuous or pulsed microwaves (2950 MHz), Baranski & Edelwejn

(1974) did not find any effects on acetylcholinesterase activity after long-term exposure (2 h/day for 3—4 months to 3.5—5 mW/cm<sup>2</sup>).

Brain hyperaemia, pyknosis, and vacuolization of nerve cells were observed in rats repeatedly exposed for 75 days to 3- and 10-cm microwaves at high power densities (40—100 mW/cm<sup>2</sup>) (Tolgaskaya et al., 1962; Tolgaskaya & Gordon, 1973). These effects were less pronounced following exposures at 10—20 mW/cm<sup>2</sup> and with exposure to 3-cm microwaves compared with 10-cm microwaves at the same power density. The effects were reversible, several days after termination of the experiment.

The blood-brain barrier of rats may be affected by pulsed and continuous wave microwave radiation at 1.2 GHz (Frey et al., 1975). A single exposure of 30 min at an average power density of 0.2 mW/cm<sup>2</sup> pulsed and 2.4 mW/cm<sup>2</sup> continuous wave radiation led to an increase in permeability. In another study on rats, Oscar & Hawkins (1977) found temporary alterations in permeability following single 20-min exposures to 1.3 GHz radiation at power densities of about 1 mW/cm<sup>2</sup> pulsed and 3 mW/cm<sup>2</sup> cw. Many other investigators including Merrit (1977) and Sutton & Carrell (1979) were unable to reproduce these experimental results.

In studies by Wachtel et al. (1975), exposure of individual neurons to 1.5 GHz and 2.45 GHz microwave radiation at a dose rate of approximately 10 mW/g had a marked effect on the firing pattern of Aplysia neurons. Although heating may have been partially responsible, the authors suggest that other factors are needed to explain the effect. Rectification of the applied field in nerve tissue could explain the observed effects.

The threshold power density required to evoke potentials in the brain stem of cats using nonperturbing electrodes was found to be approximately 0.03 mW/cm<sup>2</sup> with a peak of 60 mW/cm<sup>2</sup> for frequencies between 1.2—1.5 GHz (Frey, 1967).

Stverak et al. (1974) found that rats having an inherent predisposition to epileptic seizure after sound stimulation showed reduced sensitivity of this phenomenon following long-term (4 h/day for 10 weeks) exposure to 2850 MHz radiation, pulsed for 10  $\mu$ s, repetition frequency 769.2 Hz, at an average power density of 30 mW/cm<sup>2</sup>.

Behavioural perturbations in rats in the form of work stoppage have been reported by Justesen & King (1970) and Lin et al. (1979). Exposure of hungry unrestrained rats to 2.45 GHz microwaves at a dose rate of approximately 9 mW/g caused stoppage of work for food after 20 min of exposure in a multimode cavity (Justesen & King, 1970). With restrained rats irradiated with near-field radiation at 918 MHz, the threshold dose rate for the effect was 8 mW/g (Lin et al., 1979). It was calculated by Justesen (1978) that an integral dose between 8 and 10 J/g was required for work stoppage in hungry rats, e.g., 23 min exposure to an average power density of 20 mW/cm<sup>2</sup> at 600 MHz (resonant frequency for the rat) or 46 min

exposure to the same power density at 400 MHz. The work stoppage was found to be related to the specific absorption rate, suggesting a thermal basis for the effect.

In studies by Moe et al. (1977), rats exposed for 210 h to 918-MHz radiation at 10 mW/cm<sup>2</sup> showed decreased locomotor activity and food intake. This behavioural change could be attributed to thermal loading, even though the animals were not under hyperthermic stress.

The effects on exploratory activity, swimming, and discrimination involving a vigilance task were studied in rats exposed to 2.45 GHz pulsed radiation (Hunt et al., 1975). A dose rate of 6 mW/g caused a moderate decrease in the level of exploratory activity and swimming speed. The results were attributed to fatigue from thermal overexposure, since the effect on vigilance discrimination was observed to be directly related to induction of and recovery from hyperthermia. Nearly lethal radiation (11 mW/g) initially produced a marked degradation in performance, but the rats returned to the trained level of proficiency after 1 h.

Microwave radiation was found to affect the behaviour of rats conditioned to respond to multiple schedules of reinforcement (Thomas et al., 1975). Exposure for 30 min to 2.86- and 9.6-GHz pulsed radiation, and to 2.45-GHz cw radiation just before experimental sessions at power densities exceeding 5 mW/cm<sup>2</sup> caused significant alterations in behaviour.

Roberti et al. (1975) did not find any difference in the spontaneous motor activity of rats after exposure for periods totalling 408 h to 10.7- and 3-GHz microwaves at power densities ranging from 0.5 to 26 mW/cm<sup>2</sup>. Classical Pavlovian methods were used by Svetlova (1962) and Subbota (1972) to investigate reflex and conditioned reflex actions in microwave-irradiated dogs, by determining the time of initiation of saliva secretion following the conditioning stimulus, the latency time, and the number of drops secreted. After lateral exposure to 10-cm microwaves for 2 h at power densities ranging from 1—5 mW/cm<sup>2</sup>, the intensity of the response increased on the opposite side, and the latency time was shortened. However, following 70 h of exposure in 35 days (2 h/day), the conditioned responses became identical to those before irradiation showing that a gradual adaptation of the dogs' responses to successive microwave exposures occurred.

Galloway (1975) investigated the effects of 2.45 GHz cw microwave exposure on discrimination and acquisition tasks in trained rhesus monkeys. The heads of the animals were exposed directly with energy deposited at rates ranging from 5 to 25 W (for a 1.2 kg head the resulting average dose rate was between 4 mW/g and 21 mW/g). Before testing, the monkeys were given a dose of 2.5 J/g over 2 min. Convulsions occurred in all animals irradiated at 25 W and in some at 15 W, an integral dose approaching 25 J/g (the dose

required to produce convulsions (Justesen, 1978)) was given. It is apparent that hot spots were produced in the monkey's brains to induce this effect. Exposure to 10 W for 5 days, for 40 min per day did not produce any performance deficit, even in animals suffering from skin burns and severe convulsions caused by exposure to high power radiation.

The performance of a vigilance task was investigated in rhesus monkeys after whole body exposure to 2.45 GHz far-field radiation. Behaviour was not disrupted provided that increases in colonic temperature did not exceed 1 °C. With a 1-h exposure, the threshold of behavioural disruption was 70 mW/cm<sup>2</sup> (De Lorge, 1976).

Exposure to continuous wave microwave radiation of 1.2 GHz at average power densities of 10–20 mW/cm<sup>2</sup> did not affect skilled motor performance in monkeys even when the animals were positioned for maximum energy deposition in the brains and subjected to three 2-h periods of exposure (Scholl & Allen, 1979).

A number of studies including some of those already discussed and others for comparison are summarized in Table 15. The results obtained by different investigators vary according to exposure conditions and the end-point investigated. Interpretation of these observations is difficult since many observations are either controversial or contradictory. Data tend to be better substantiated at power densities above 5–10 mW/cm<sup>2</sup>.

In 1961, Frey reported the sensory effect of "microwave hearing". Man perceives an audible clicking or buzzing sensation on exposure to pulsed radiation at low power densities. He (Frey, 1971) considered that the effect was caused by direct neural stimulation but later studies by Foster & Finch (1974) and Chou et al., (1977) have strongly indicated that an electromechanical interaction occurs due to thermal expansion. The threshold of microwave hearing is approximately 10 mJ/g per pulse and is independent of the pulse width for pulses of less than 30 microseconds (Guy et al., 1975a). Microwave hearing is now thought to be caused by a small but fast rise in temperature which, by thermal expansion, generates a wave of pressure exciting the cochlea.

To summarize, it can be stated that studies on the effects of microwaves/RF radiation on the nervous system indicate that exposure at low-power densities appears to induce detectable changes in some cases (Cleary, 1977). While there seems to be evidence that, at sufficiently high intensities (above 1–5 mW/cm<sup>2</sup>), nonuniform heating of various critical organs takes place in experimental animals, it is not possible at present to exclude other mechanisms. Furthermore, it is difficult to evaluate the significance of microwave-induced behavioural effects because of the general lack of quantitative correlations between thermal effects at low power densities and responses at the physiological or psychological levels of analysis (Cleary, 1977).

Table 15. Neural effects of exposure to low-intensity fields

Independent variables	Dependent variables	Experimental subject	Results and comments	Reference
200 Hz; 10 ms pulsed field; 20–50 mV/cm	cerebral Ca <sup>+2</sup> efflux	cat-direct cortical stimulation ( <i>in vivo</i> )	20 % increase in Ca <sup>+2</sup> efflux from neurons.	Kaczmarek & Adey, (1974)
147 MHz, AM modulated at 6, 9, 11, 16 Hz; 1–2 mW/cm <sup>2</sup> (closed irradiation system)	cerebral Ca <sup>+2</sup> efflux	chick fore-brain ( <i>in vivo</i> )	Increase in Ca <sup>+2</sup> from neurons; no change from unmodulated fields; maximum rate of efflux at 11 Hz and alterations in neuron firing patterns at intensity equivalent to 10 mW/cm <sup>2</sup> free field exposure.	Bawin et al. (1975)
ELF fields, 1–75 Hz; 0.5 to 1 V/cm (closed system irradiation)	cerebral Ca <sup>+2</sup> efflux	isolated chick and cat cerebral tissue ( <i>in vivo</i> )	Suppression in Ca <sup>+2</sup> release from neurons; biphasic intensity & frequency dependence; maximum effect at 6 and 16 Hz; 0.1 and 0.56 V/cm.	Bawin & Adey (1976)
1.5 and 2.45 GHz, cw and pw (closed irradiation system)	electrical activity of individual neurons	aplysia ganglia ( <i>in vivo</i> )	Effects attributed to ganglionic warming, but effects not produced by non-radiation heating.	Wachtel et al. (1975)
2.45 GHz, cw	functional alterations in neuronal elements	spinal cord of cat ( <i>in vitro</i> )	Alteration in evoked potentials also produced by non-radiation heating but with change in timing.	Taylor & Ashlehen, (1975)
3 GHz, pw; 5 mW/cm <sup>2</sup> ; pulse repetition rate 500–600 Hz (free field exposure)	electrical activity of cortical neurons	rat ( <i>in vivo</i> )	10-day exposure resulted in synchronization of electronic frequency; synchronization persisted for hours after exposure.	Servantie et al. (1975)
2.45 GHz, cw, 0.3–1500 mW/g, pw; 0.3–2.2 x 10 <sup>5</sup> mW/g temperature controlled exposure (closed system irradiation)	synaptic transmission; neural function	rabbit vagus nerves, superior cervical ganglia; rat diaphragm muscle ( <i>in vitro</i> )	No changes other than those thermally-induced.	Chou & Guy (1975)
3.1 GHz; pw 10–400 W/kg Mean 5 · 10 <sup>4</sup> to 2 · 10 <sup>6</sup> W/kg peak temperature controlled exposure (free space irradiation).	axonal transport & microtubules	rabbit vagus nerve & brain extracts ( <i>in vivo</i> )	No effects.	Paulsson et al. (1977)
decimeter waves; 0.5 mW/cm <sup>2</sup> (free space irradiation)	neurotransmitter release	rabbit ( <i>in vivo</i> )	Decreased acetylcholinesterase (AChE) activity.	Syngajevskaja, et al. (1962)
10 cm, 0.5 mW/cm <sup>2</sup> (free space irradiation)	neurotransmitter release in brain	rabbits & guinea pigs ( <i>in vivo</i> )	No alteration caused by 8-month exposure to 1 mW/cm <sup>2</sup> ; with 3-h exposure to 3.5 mW/cm <sup>2</sup> , no cw effect but pw decreased AChE activity in guinea pigs; after	Baranski (1967)

Table 15 (contd).

Independent variables	Dependent variables	Experimental subject	Results and comments	Reference
1.6 GHz; 80 mW/cm <sup>2</sup> environmental temperature (free space irradiation)	neurotransmitter release in brain	rats ( <i>in vitro</i> )	4 months exposure, there was a decrease with cw and an increase with pw; midbrain most affected; lipid & nucleoprotein metabolism altered in rabbit.	Merritt et al. (1976)
1.7 GHz, cw; 10 and 25 mW/cm <sup>2</sup> (free space irradiation)	histological alterations in brain	Chinese hamster ( <i>in vitro</i> )	30–120 min exposure led to cytopathological effects in hypothalamic and subthalamic neurons; no effect on other brain regions or on glial cells; no repair evident 14 days after exposure.	Albert & DeSantis (1975)
960 MHz, cw; 2–10 mW/g (closed system irradiation)	heart rate	isolated turtle heart ( <i>in vitro</i> )	Bradycardia due to alteration in neurotransmitter release; biphasic intensity response.	Tinney et al. (1976)
10.5 cm, cw; 0.5–10 mW/cm <sup>2</sup> ; temperature-controlled exposure (free space irradiation)	passive and dynamic electric parameters	skeletal muscle, South American frog ( <i>in vivo</i> )	Differential effect of microwave exposure on dependent variable time constants; muscle cells of summer frogs more sensitive than those of winter frogs.	Portela et al. (1975)
3 & 10.7 GHz, cw; 0–526 mW/cm <sup>2</sup> 408-h exposure (free field exposure)	behavioural modification (spontaneous motor activity)	rat ( <i>in vivo</i> )	No effects on spontaneous motor activity.	Roberti et al. (1975)
9.4 GHz, pw; 2.3 mW/cm <sup>2</sup> & 0.7 mW/cm <sup>2</sup> average; 2 week exposure (free field exposure)	behavioural modification (free field spontaneous behaviour)	rat ( <i>in vivo</i> )	Control results: decrease in locomotor activity, & vigilance; increase in exploratory activity; exposed results: increased exploratory activity (slower than controls); increase then decrease in vigilance, uniform locomotor.	Gillard et al. (1976)
2.45 GHz, pw; 5, 10, 15 mW/cm <sup>2</sup> , 30-min exposures (free field exposure)	behavioural modification (fixed consecutive number switching frequency)	rat ( <i>in vivo</i> )	Dose-dependent increase in the frequency of premature switching alteration (in the perception).	Thomas et al. (1975)
2.45 GHz, cw; 4–72 mW/cm <sup>2</sup> ; 30, 60, 120-min exposures (free field exposures)	behavioural modification (auditory vigilance task)	rhesus monkey ( <i>in vivo</i> )	vigilance performance not affected by exposure.	De Lorge (1976)

Table 15 (contd).

Independent variables	Dependent variables	Experimental subject	Results and comments	Reference
2.45 GHz, cw; 2-min exposure, 5—25 W output (applicator exposure of head)	behavioural modification (discrimination and repeated acquisition)	rhesus monkey ( <i>in vivo</i> )	Convulsions induced at 15 and 25 W; irradiation 40 min/day for 5 days did not produce any behavioural effects at less than 15 W; no low-intensity effects.	Galloway (1975)
9.3 GHz, cw; 0.7—2.8 mW/cm <sup>2</sup> , 5—min exposure (free field exposure)	amplitude of cortical brain waves in anaesthetized animals (pentobarbital)	rabbit ( <i>in vivo</i> )	Atypical arousal phenomena. 3—12 min after exposure, followed in 3—5 min by longer period of arousal; atypical behaviour.	Goldstein & Sisko (1974)
2.45 and 1.7 GHz, cw & pw; 5—50 mW/cm <sup>2</sup> (free field exposure)	duration of pentobarbital-induced sleeping time	rabbit ( <i>in vivo</i> )	Dose-dependent anaesthetic effect.	Cleary & Wangemann (1976)
3 GHz, pw; 5 mW/cm <sup>2</sup> (free field exposure)	effects of drugs on CNS	mice ( <i>in vivo</i> ) rats ( <i>in vivo</i> ) and ( <i>in vitro</i> )	Exposure delayed onset of pentetrazol-induced convulsion during first 15 days of exposure, reduced latency after 15 days; decreased susceptibility to curare-like drugs in <i>in vivo</i> and <i>in vitro</i> systems.	Servantie et al. (1974)
Occupational microwave & RF exposure	CNS drug tolerance (cardiazole)	human subjects ( <i>in vivo</i> )	Altered EEG patterns and convulsions in workers with over 3 years microwave exposure (similar results reported in rabbits).	Edelwejn & Baranski (1966) Baranski & Edelwejn (1968)
occupational microwave & RF exposure	CNS functional disorders	human subjects ( <i>in vivo</i> )	Transient subjective complaints during first year of exposure; phasic adaptation after 1 year; objective symptoms of neurovegetative disturbances after 5 years of exposure (acrocyanosis, hyperhidrosis, dermographism, hypotonia tremors).	Petrov (1970)
3.1 GHz; pw, 55 mW/cm <sup>2</sup> , repeated or single 1-h exposure (free space irradiation)	histological alterations in retina	rabbit ( <i>in vivo</i> )	Cytopathological effects in the plexiform layers of retina, no effects on photoreceptors; alterations persisted for 3 months after radiation.	Paulsson et al. (1979)

From: Cleary (1978).

## 7.5 Effects on the Blood Forming and Immunocompetent Cell Systems

Studies have been conducted on the effects of microwave radiation on blood and the immunocompetent system, but the results



are frequently contradictory and the reasons for the discrepancies are not always easily identified. For example, in 1962, Prausnitz & Susskind irradiated 100 mice with 9270 MHz microwaves at 100 mW/cm<sup>2</sup> for 9.5 min daily over a period of 59 weeks and reported an increase in white blood cells accompanied by lymphocytosis. It was reported that leukaemia occurred in 35% of exposed mice, compared with 10% of the controls. However, it appears that no attempt has been made to replicate these studies.

A decrease in erythrocytes, leukocytes, and haemoglobin in mice was observed by Gorodeckij, ed. (1964) immediately after exposure to 10 GHz at 450 mW/cm<sup>2</sup> for 5 min, and 1 and 5 days later, while recovery was evident after 10 days. The influence of microwaves on the response of immunocompetent lymphocytes was investigated in mice by Czerski (1975). The animals were exposed to 2.95 GHz microwaves at  $0.5 \pm 0.2$  mW/cm<sup>2</sup> for 2 h per day, 6 days per week for 6 and 12 weeks. During the 2-h exposure, the animals were deprived of food and water and were located in separate cages. After exposure, the animals were immunized with antigen and the immune response determined by the number of antibody-forming cells in the lymph nodes. Significant differences were found between the control group and the group exposed for 6 weeks, but not the group exposed for 12 weeks. The author attributed this result to adaptation. In nonimmunized irradiated mice there was an increased number of lymphoblasts in lymph-node cells, but no differences in the number of plasmocytes.

Blast transformation of human lymphocytes *in vitro* was observed by Stodolnik-Baranska (1967, 1974) after exposure to 2950 MHz microwaves at power densities of 7 and 20 mW/cm<sup>2</sup>. However, Smialowicz (1977) was unable to detect any differences between the blastogenic responses of microwave-exposed (2450 MHz, 19 W/kg for 1–4 h) and control mouse splenic lymphocytes activated with various mitogens *in vitro*.

The effects on haemopoietic-stem cells in mice of exposure to 2.45 GHz microwaves at 100 mW/cm<sup>2</sup> for 5 min were investigated by Kotkovská & Vacek (1975). The response appeared to occur in 2 stages. In the first, the number of leukocytes in the blood increased and both bone marrow and spleen cell numbers decreased for 3–4 days following exposure. In the second stage, the number of nucleated cells in the spleen and the total number of cells in the femur, as detected by incorporation of <sup>59</sup>Fe, increased until the twentieth day after exposure. The incorporation of <sup>59</sup>Fe in the spleen decreased to 78% of the control value 24 h after exposure and increased to 50% after 14 days.

When Lin et al. (1979) studied the effects on mice of single and repeated exposures to 148 MHz radiation at 1 mW/cm<sup>2</sup> for 1 h per day, 5 days per week for ten weeks, they did not find any significant changes in the blood.

In studies on 3 strains of rats, a 7-h exposure to 24 GHz microwave radiation at 20 mW/cm<sup>2</sup> induced significant leukocytosis, lymphocytosis, and neutrophilia with recovery in 1 week; after a 10-min exposure at 20 mW/cm<sup>2</sup> or a 3-h exposure at 10 mW/cm<sup>2</sup>, recovery occurred in 2 days (Deichman et al., 1964). The changes observed were strain-dependent because in 2 strains the number of leukocytes, erythrocytes, and neutrophils increased, while in one strain it decreased.

Decreases in lymphocytes, erythrocytes, and leukocytes, and increases in granulocytes and reticulocytes were observed in rats by Kitsovskaja (1964) after 3 GHz exposure at 40 mW/cm<sup>2</sup> (15 min per day for 20 days) and 100 mW/cm<sup>2</sup> (5 min per day, for 6 days). Exposure at 10 mW/cm<sup>2</sup> (1 h per day for 216 days) resulted in decreases in total WBC and lymphocytes and an increase in granulocytes with no changes in other blood components. However, in a study on rats exposed to 2.4 GHz microwaves at 5 mW/cm<sup>2</sup> (1 h per day for 90 days), Djordjevic et al. (1977) did not observe any significant differences in the haematocrit, mean cell volume, and haemoglobin between the exposed and control groups during 90 days of exposure and for 30 days afterwards. Furthermore, there were no significant differences in the number of leukocytes, erythrocytes, lymphocytes, and neutrophils.

Smialowicz et al. (1977) completed a comprehensive study on rats chronically exposed to 425 MHz radiation at 10 mW/cm<sup>2</sup> (SAR, 3—7 mW/g) and to 2.45 GHz radiation at 5 mW/cm<sup>2</sup> (SAR, 1—5 mW/g). The rats were exposed *in utero* and for the first 40 days of life for 4 h per day. The only change in the haemopoietic or immunocompetent systems was observed in the response of lymphocytes to mitogen.

The effects on guineapigs and rabbits of prolonged intermittent exposures to 3 GHz radiation at 3.5 mW/cm<sup>2</sup> for 3 h per day over 3 months were investigated by Baranski (1971). Increases in absolute lymphocyte counts in peripheral blood, and abnormalities in nuclear structure and mitosis in erythroblast cells in the bone marrow, and in lymphoid cells in lymph nodes and spleen, were found. Rabbits exposed at 3 mW/cm<sup>2</sup> (2950 MHz continuous and pulsed) for 2 h per day, for 27 and 79 days showed a decrease in erythropoiesis, as determined by <sup>59</sup>Fe uptake. Pulsed radiation was found to be more effective than continuous radiation at the same power level (Czerski et al., 1974a).

The effects on blood serum in rabbits exposed to 2.45 GHz continuous and pulsed radiation at 5, 10, and 25 mW/cm<sup>2</sup> for 2 h were investigated by Wangemann & Cleary (1976). Changes in the blood chemistry of animals irradiated at the three power densities were found to be consistent with a dose-dependent response to thermal stress. Out of the ten serum components that were analysed, statistically significant increases were observed in serum glucose, blood urea

nitrogen, and uric acid. Dose-dependent transient increases returned to normal levels during the week following exposure. No differences in the animal's responses to cw and pulsed radiations (10-micro-second duration, peak power 485 mW/cm<sup>2</sup>) were found at the same average power density.

Dogs were exposed to 1285 MHz, 2.8 GHz and 24 GHz at power densities between 20 and 165 mW/cm<sup>2</sup> (Michaelson et al., 1964, 1971). Following exposure to 1285 MHz radiation at 100 mW/cm<sup>2</sup> for 6 h, a marked increase in leukocytes and neutrophils was found. After 24 h, the neutrophil count continued to increase but the lymphocyte and eosinophil counts decreased. Neutrophil counts after exposures at 50 and 20 mW/cm<sup>2</sup> (1285 MHz) did not differ significantly from those of control animals. A decrease in lymphocytes was noted after the exposures at 100 mW/cm<sup>2</sup> and 50 mW/cm<sup>2</sup>, but not after that at 20 mW/cm<sup>2</sup> (Michaelson et al., 1971). Haematological examination of the dogs for 12 months after exposure at 20 mW/cm<sup>2</sup> did not reveal any end points that differed from the control groups.

A number of studies are listed in Table 16 with details of exposure conditions and results of microwave-induced changes in the haemopoietic and immunocompetent cell systems.

This section on the effects of microwaves on the blood forming and immunocompetent cells can be summarized as follows:

(a) Changes in the red and white blood cell counts seem to depend on the dose of microwave energy applied. In most of the studies reporting positive findings, the effects seem to result from thermal stress.

(b) Repeated exposures to 5 mW/cm<sup>2</sup> or below do not appear to affect the peripheral blood picture. Effects reported from exposures to 15 mW/cm<sup>2</sup> or more, depending on the biological system exposed, tend to be reversible following termination of exposure.

(c) The response of the haemopoietic system to microwave radiation is significantly different from that to exposure to elevated ambient temperatures, even when both result in the same increase in rectal temperature. This can be attributed to the nonuniform deposition of microwave energy in the body, and the greater depth and rate of heating.

(d) There is evidence that lymphocyte stimulation and effects on response may occur under certain experimental conditions, especially after exposure to pulsed radiation for repeated or prolonged periods at sufficiently high power densities.

## 7.6 Genetic and Other Effects in Cell Systems

Investigations of biological systems such as cells in culture are conducted to gain an understanding of basic mechanisms of inter-

Table 16. Microwave-induced effects induced in the blood-forming and immunocompetent cell systems<sup>a</sup>

Radiation Frequency (GHz)	Intensity (mW/cm <sup>2</sup> )	Exposure duration	Species	Results	Reference
3	1,5	15,30	granulocyte cells in culture	Liberation of hydrolases (1 mW/cm <sup>2</sup> ) cell death (5 mW/cm <sup>2</sup> ; 60 min) lysosomal enzyme release (5 mW/cm <sup>2</sup> ; 60 min).	Szmigielski (according to Cleary (1978))
2.95	0.5	2 h/day for 6 days/week for 6 and/ 2 weeks	mouse	Lymphoblasts in lymph nodes, lymphoblastoid transformation during first 2 months and 1 month after exposure.	Czerski (1975 b)
2.45	100	5 min	mouse	Leukocyte (2 maxima) total cell volume in the bone marrow and spleen, <sup>59</sup> Fe incorporation into spleen, nucleated cells in spleen immediately after exposure total cell number in femur 5—7 days after exposure, Colony forming unit numbers of stem cells, return to normal 12 h after exposure.	Rotkowska & Vacek (1975)
3.0	3.5	4 h/day	rat	Leukocyte, altered nuclear structure, altered mitotic activity in erythroblasts, bone marrow cells & lymphatic cells in lymph nodes & spleen.	Baranski (1971)
24	220,10	varied	rat	Leukocyte lymphocyte neutrophil, all cell counts returned to normal in 7 days.	Deichman et al. (1959)
2.95	3	2 h/day for 37 days pw & cw, 2 h/day for 79 days cw	rabbit	Erythrocyte production alterations in circadian rhythms in haemopoietic cell mitosis. <sup>a</sup>	Czerski et al. (1974 a)
2.45	3,10,25	2 h	rabbit	Serum glucose blood urea nitrogen, uric acid, all values return to normal 7 days after exposure.	Cleary & Wangemann (1978)
1.28, 2.8	100—165	7 h	dog	Maximum increase in <sup>59</sup> Fe incorporation 45 days after exposure.	Michaelson et al. (1961)

<sup>a</sup> From: Bramall (1971).

action. Although, these systems are less complex and the dosimetry can be better quantitated than in animal studies, the results have to be interpreted carefully in assessing potential health hazards to man.

Microwave exposure has been reported to produce chromosomal aberrations (Janes et al., 1969; Mykolajczyk, 1970; Yao & Jiles, 1970; Baranski et al., 1971; Yao, 1971; Czerski et al., 1974b) and mitotic alterations (Baranski et al., 1969; Mykolajczyk, 1970; Baranski et al., 1971; Baranski, 1972; Czerski et al., 1974) in cells.

Yao & Jiles (1970) studied the effects of microwave radiation on cell proliferation and on the induction of chromosomal aberrations in cultured rat kangaroo cells. Cells were exposed to 2.45 GHz radiation in the near field at 1 W/cm<sup>2</sup> and 5 W/cm<sup>2</sup> and in the far field at 0.2 W/cm<sup>2</sup>. Exposure to 0.2 W/cm<sup>2</sup> for 1 min caused increased cell proliferation, but after 30 min, it decreased. Exposure at higher power densities significantly reduced the rate of proliferation. Exposure at 5 W/cm<sup>2</sup> induced chromosomal aberrations, but it is evident that high temperatures were involved in this result, since the energy absorption rate measured was 15.2 mW/g.

Chromosomal aberrations and changes in the duration of particular phases of mitosis (mitotic abnormalities) were reported by Baranski et al. (1969, 1971) in human lymphocyte cultures and cultures of monkey kidney cells following exposures at 3 and 7 mW/cm<sup>2</sup> to 10 cm pulsed and cw microwaves. Mitotic disorders in the lymphocytes of guineapigs and rabbits were also found following exposure to 3 GHz at 3.5 mW/cm<sup>2</sup> for 3 h per day over 3 months (Baranski, 1972).

Manikowska et al. (1979) studied 16 mice subjected to 9.4 GHz pulsed (width 0.5  $\mu$ s, repetition rate 1000 Hz) microwaves at power densities of 0.1, 0.5, 1.0 and 10 mW/cm<sup>2</sup> for 1 h/day for 2 consecutive weeks (5 days/week). Disturbances in meiosis were detected at power density levels as low as 0.1 mW/cm<sup>2</sup>. This study needs confirmation since no other studies on effects of microwaves on meiosis could be found.

Exposure of murine splenic lymphocytes *in vitro* to 2450 MHz radiation at 10 mW/cm<sup>2</sup> (dose rate of 19 mW/g) did not result in any changes in capacity to synthesize DNA (Smialowicz, 1977). This technique used to assess blastic transformations of lymphocytes, was not the same as that used by Baranski (1972), which may explain the discrepancy in results. Elder & Ali (1975) found similarly negative results when they exposed mitochondria of isolated rat liver to 2.45 GHz radiation at 10 and 50 mW/cm<sup>2</sup> for 3.5 h. Furthermore, no effects were found in oxidation of substrate, electron transport, oxidative phosphorylation, or calcium transport.

The effects of 2450 MHz microwaves and a 43 °C water bath on normal and virus-transformed fibroblasts of mice were compared by Janiak & Szmigielski (1977). Short-term heating by both methods resulted in reversible changes in the active transport of potassium through the cell membrane. Prolonged heating (over 20 min at 32 °C) caused irreversible damage and the membrane became permeable to large molecules.

In another comparative study, Lin & Cleary (1977) did not find any differences in the release of potassium ions, haemoglobin levels, and the osmotic fragility of the red-cell membrane between samples exposed to microwaves at 2.45, 3.0, and 3.95 GHz and conventionally heated samples.

Chinese hamster ovarian cells exposed to 2.45 GHz microwaves or treated in a water bath at the same temperature did not show any differences in response when cell survival and sister chromatid exchanges were the end points (Livingston et al., 1979).

In studies by Blackman et al. (1975), the colony forming ability of *Escherichia coli* B was not inhibited by exposure to 1.7 GHz, 2.45 GHz, 68–74 GHz, and 136 GHz at power densities ranging from 0.3 to 20 mW/cm<sup>2</sup>. This was in contrast to an inhibitory effect of microwave radiation at 136 GHz previously reported (Webb & Dodds, 1968). However, in a more recent study of colony-forming ability and of alterations in the molecular structure of living *E. coli* B, there were no changes in colony growth, or in molecular structure or conformation after irradiation at frequencies between 2.6 and 4 GHz with a specific absorption rate of 20 mW/g (Corelli et al., 1977).

Thus, it can be concluded that:

(a) Chromosomal aberrations and mitotic alterations can be produced by microwaves at high power densities where thermal mechanisms play a definite role. However, as there are many conflicting reports, some doubts remain as to whether these effects can occur at lower power densities.

(b) Studies at the cellular and subcellular level are important for understanding basic interaction mechanisms. Chromosomal aberrations and mitotic alterations are potential early indications of biological changes and may reflect a response of specific tissue, but not genetic injury in the organism.

(c) Recent studies on cell proliferation and capacity to synthesize DNA indicate that power densities sufficient to produce thermal damage are necessary for effects to appear. This is shown by experiments comparing the effects of both water baths and microwave exposure. Exposure of animals to resonant frequencies (e.g., 2450 MHz for mice), could be expected to induce effects at low power densities because a larger proportion of the incident radiation is absorbed and converted into heat.

## 7.7 Effects on Reproduction and Development

Detrimental effects of microwaves on testicular function, impregnation, developing embryos, and on offspring have been reported in the literature.

Van Ummersen (1961) exposed 48-h chick embryos to 2450 MHz cw microwave radiation through the intact shell. The power density was 20–40 mW/cm<sup>2</sup> and exposures were given for 280–300 min, causing the yolk temperature to rise from 37 °C to 42.5 °C. Abnormalities which were observed appeared to be caused by the inhibition of cell differentiation and growth. Development of hind

limbs, tail, and allantois was suppressed. When control eggs were incubated at 42.5 °C for the same length of time and the temperature of the eggs was the same as that of microwave-treated eggs, no abnormalities were found. It was concluded that the abnormalities from microwave exposure were caused by other than thermal factors.

Mice were subjected to 2.45 GHz microwaves at the near lethal dose rate of 38 mW/g for 10 min per day during the 11th—14th days of gestation. There were no increases in fetal mortality or deformations in treated animals compared with untreated controls and maze performance was the same in both groups (Chernovetz et al., 1975).

When rats were irradiated between days 1 and 16 of pregnancy with 27 MHz radiation at power densities that caused the rectal temperature to rise to 42 °C, a variety of teratological effects related to the developmental stage of the fetus was found. The effect on the development of the rat of repeated exposures *in utero* to 2.45 GHz radiation at 10 mW/cm<sup>2</sup> for 5 h per day from day 3 to day 19 of gestation was investigated by Shore et al. (1977). Two groups of animals were exposed under different conditions of configuration in the field. One group was placed in the exposure field in such a way that the long axis of each animal was parallel to the electric field; animals of the second group were placed with the long axis parallel to the magnetic field (orientation parallel to the electric field results in substantially greater absorption of microwave energy). No significant differences in litter size were observed between the control and irradiated animals. Decreases in body and brain mass were observed in animals irradiated with the long axis of the body parallel to the electric field.

Rats were exposed to 2.45 GHz radiation at 10 and 40 mW/cm<sup>2</sup> for 1 h per day during critical periods of gestation, and their functional development was studied during the 21-day period to weaning (Michaelson et al., 1977a). Offspring of rats exposed at 40 mW/cm<sup>2</sup> showed a significantly higher level of corticosterone during the first 24 h of life and an increase in levels of thyroxin at 14 and 16 days of age. Thyroxin levels tended to be lower in one-week-old rats from dams that had been exposed at 10 mW/cm<sup>2</sup>, but increased during the second week of life. Adrenal wet mass and ratios of adrenal-to-body mass in 7-day-old rats were significantly higher in irradiated animals. The authors suggested that while microwave radiation might change the developmental process and accelerate the rate of maturation, it might also result in some deficiencies. A similar result was found by Johnson et al. (1977) who exposed rats *in utero* to 918 MHz at 5 mW/cm<sup>2</sup> for a total of 380 h and found an increase in body mass at birth and an acceleration in the time of eye opening. Later a deficiency in avoidance response was observed.

Repeated exposures to 9.4 GHz at power density levels below  $10.0 \text{ mW/cm}^2$  may induce disturbances in spermatogenesis and meiosis in mice (Manikowska et al., 1979). However, Cairnie & Harding (1979) were unable to find any differences in the sperm counts of mice, after *in vivo* exposure to 2450 MHz radiation at  $20\text{--}32 \text{ mW/cm}^2$  for 4 days (16 h/day). Testicular damage was observed in mice exposed to 2450 MHz at a power density of  $6.5 \text{ mW/cm}^2$  for 230 h over a 2-month period (Haidt & McTighe, 1973); these positive findings could be explained on the basis of a thermal mechanism because 2450 MHz is around the resonant frequency for mice.

Changes in testicular morphology were observed by Varma & Traboulay (1975) in mice exposed to 1.7 and 3.0 GHz microwaves at  $10 \text{ mW/cm}^2$  for 100 min, and at  $50 \text{ mW/cm}^2$  for 30—40 min. Both Bereznitskaja (1968) and Polozitkov et al. (1961) reported that chronic exposure of mice to 3 GHz at  $10 \text{ mW/cm}^2$  or even lower levels resulted in a prolonged estrus cycle, partial sterility, and an increased, early mortality of the offspring. However, other research workers were unable to find any changes in the reproductive performance of dogs exposed to 24 GHz microwaves at  $24 \text{ mW/cm}^2$  for 33 and 66 weeks (Deichman et al., 1963) and to 1.28 GHz at  $20 \text{ mW/cm}^2$  (Michaelson et al., 1971) or female rats and mice exposed to 3.1 GHz at  $8 \text{ mW/cm}^2$  for prolonged periods of time and to  $300 \text{ mW/cm}^2$  for a short period of time (Shore et al., 1977).

A comparative study of heating the testes of rats by microwaves and in warm water was performed by Muraca et al. (1976). Radiation of 2.45 GHz was used at  $80 \text{ mW/cm}^2$  with the exposure time varied to maintain the desired temperature within  $\pm 0.5^\circ\text{C}$ . Repeated treatments during 5 consecutive days resulted in more damage in microwave-irradiated animals. However, it was determined that if non-thermal effects occurred, it appeared that microwave-induced heating was necessary to produce damage.

The threshold value for testicular damage in dogs exposed to 2880 MHz microwaves at more than  $10 \text{ mW/cm}^2$  for unlimited periods was studied by Ely et al. (1964). A temperature of  $37^\circ\text{C}$  was produced more rapidly with exposure to higher power densities. This temperature was determined as critical for damage based on a minimal demonstrable histological change in the most sensitive animal from the test group. The authors pointed out that the changes, including sterility, were reversible.

In summary, microwave radiation can affect reproduction and development. Both are particularly sensitive to thermal stress, although specific effects that are not attributable to heating cannot be excluded. Microwave exposure at power density levels causing temperature increases results in testicular lesions, and particularly



affects spermatogenesis, in experimental animals. These lesions seem to be readily reversible unless necrosis occurs. Baranski & Czerski (1976) in their review of the subject concluded that no serious effects should be expected at power density levels below 10 mW/cm<sup>2</sup>. Substantial differences between thermal effects induced by microwaves and by other methods of heating may be attributed to different spatial distributions of internal heating and different rates of heating. Developmental effects seem to be critically dependent on the time of exposure to microwaves making it difficult to compare some of the experimental data.

## 8. HEALTH EFFECTS IN MAN

The available data concerning the health effects of microwave radiation in man are insufficient, although some surveys of the health status of personnel occupationally exposed to microwaves have been carried out. The main difficulty in the evaluation of such information is the assessment of the relationship between exposure levels and observed effects. As often happens in clinical work, it is difficult to demonstrate a causal relationship between a disease and the influence of environmental factors, at least in individual cases. Large groups must be observed to obtain statistically significant epidemiological data. The problem of adequate control groups is controversial and hinges mostly on what is considered "adequate" (Silverman, 1973; Czerki et al. 1974a; NAS/NRC, 1977).

In view of the lack of good instrumentation, especially of personal dosimeters, the quantitation of exposure during work is extremely difficult. This is particularly the case where personnel move around in the course of their duties and are exposed to stationary and non-stationary fields, and both near- and far-field exposures. It is impossible to evaluate within reasonable limits the exposure over a period of several years. Consequently, investigation of the health status of personnel exposed occupationally to microwaves necessitates the examination of large groups of workers exposed for various periods, if any statistically valid results are to be obtained.

Observations on the health status of personnel exposed to microwaves in the USSR have been discussed in detail in monographs edited by Petrov, ed. (1970) and Tjagin (1971).

## 8.1 Effects of Occupational Exposure

Prior to the establishment of safety standards, it had been observed in some countries that occupational microwave exposure led to the appearance of autonomic and central nervous system disturbances, asthenic syndromes, and other chronic exposure effects (Gordon, 1966; Marha et al., 1971; Dumanski et al., 1975; Serdjuk, 1977). The pathogenesis of these syndromes is controversial, their existence has been reported on a number of occasions but often without the level of exposure. Another problem with earlier reports is that measurement techniques were not properly developed at that time (For a detailed discussion see Baranski & Czerski (1976) pp. 153—162). Subjective complaints consisted of headaches, irritability, sleep disturbance, weakness, decrease in sexual activity (libido), pains in the chest, and general poorly defined feelings of ill health. On physical examination, tremor of fingers with extended arms, acrocyanosis, hyperhydrosis, changes in dermatographism, and hypotonia were reported in the USSR (Gordon, 1966). Similar syndromes were reported in France by Deroche (1971) and in Israel by Moscovici et al. (1974).

Examination of the circulatory function included determination of the velocity of propagation of the pulse wave. Various coefficients may be calculated and used for the evaluation of vascular tonus and the state of the neurovegetative system. This method is widely used in the USSR, but seldom elsewhere. Disturbances in the functioning of the circulatory system are demonstrable using this method whereas, with the exception of signs of bradycardia, no significant findings are obtained using electro-, vecto-, and ballistocardiography. Mechanocardiography demonstrated normal or increased systolic and minute heart volume in individuals with hypotonia (Tjagin, 1971).

Gordon (1966) and her colleagues reported studies on occupationally exposed workers who were divided into 3 groups according to levels of exposure to microwave radiation:

(a) Periodic exposure at power densities from 0.1 to 10 mW/cm<sup>2</sup> (and higher) of maintenance personnel and workers, who had been employed in repair shops since 1953;

(b) Periodic exposure at power densities from 0.01 to 0.1 mW/cm<sup>2</sup> of technical maintenance workers, some users of microwave devices, and research workers, employed after 1960; and

(c) Systematic low-level exposure of personnel using various microwave devices, mainly radar.

Functional changes in the nervous and cardiovascular systems were reported in the first 2 groups. In the first group, a marked disturbance in cardiac rhythm, expressed by variability or pronounced bradycardia was reported. In the third group, similar effects were observed but symptoms were less evident and easily

reversed. Only about 1000 individuals were observed over a period of 10 years and some doubts exist regarding the exact exposure received by the workers.

Clinical observations on the health status of 2 groups of workers occupationally exposed to emissions from various types of radio equipment were reported by Sadčikova (1974). The first group consisted of 1000 workers exposed to RF radiation at a few  $\text{mW}/\text{cm}^2$ , the second group, of 180 workers who had been exposed at a few hundredths of a  $\text{mW}/\text{cm}^2$  over short periods of time. A control group of 200 was matched with respect to sex, age and character of work. The health status of both exposed groups was reported to differ considerably from that of the controls, with a higher incidence of changes in the nervous and cardiovascular systems in the exposed groups.

In Poland (Siekierzynski, 1974; Czerski et al., 1974c; Siekierzynski et al., 1974a,b), a selected group of 841 males, aged 20—40 years and occupationally exposed to microwaves at power densities ranging from 0.2 to 6  $\text{mW}/\text{cm}^2$ , was studied. No relationship was found between the level or length of occupational exposure and the incidence of disorders or functional disturbances such as organic lesions of the nervous system, changes in the translucent media of the eye, primary disorders of the blood system, neoplastic diseases or endocrine disorders, neurasthenic syndrome, disturbances of the gastrointestinal tract, and cardiocirculatory disturbances with abnormal ECG.

A 3-year epidemiological study aimed at determining health risks from microwave exposure in US naval personnel was reported by Robinette & Silverman (1977). Mortality, morbidity, reproductive performance, and health of children were investigated in 20 000 occupationally exposed subjects and 20 000 controls. No significant differences were found between the 2 groups.

Cases of whole body or partial body overexposure may occur among personnel operating high-power equipment. Exposure of the head and resultant injury to the brain have been reported (Servantie et al., 1978). The person concerned may not realize that exposure is taking place, if there is no sensation of heat. The symptoms may appear later, and a syndrome of meningitis or symptoms similar to those of heat stroke may develop.

It has been emphasized by many research workers, including Silverman (1973), that the inadequacies and uncertainties of radiation measurements and exposure data from existing, clinical studies, make it impossible to determine if, and under what conditions, microwave radiation can induce neural or behavioural changes in man. Unfortunately, the same problem exists for other studies carried out on human subjects exposed to microwaves, making it difficult to draw conclusions on health status.

### **8.1.1 Effects on the eyes**

Epidemiological surveys of lenticular effects in microwave workers have been performed in Poland (Siekierzynski et al., 1974a, b; Zydecki, 1974), Sweden (Tengroth & Aurall, 1974) and the USA (Cleary & Pasternack, 1966; Appleton & McCrossan, 1972; Shacklett et al., 1975). No statistically significant increases in the number of cataracts in personnel occupationally exposed to microwave radiation were observed in any of the surveys. Tengroth & Aurell (1974) indicated a statistically significant increase in lenticular defects and retinal lesions in 68 workers in a Swedish factory, where microwave equipment was tested. These authors were some of the first to point out possible retinal lesions from exposure to microwaves. However, survey data on the intensity of radiation were not provided and the control group was not age-matched. Statistically significant differences in lens opacities between exposed and control groups were not found in any of the other surveys. In cases of confirmed cataracts, there had been reported exposures at densities exceeding  $100 \text{ mW/cm}^2$ ; indeed, power densities as high as  $1000 \text{ mW/cm}^2$  were cited.

### **8.1.2 Effects on reproduction and genetic effects**

There is little information on the effects of microwave radiation on male or female reproductive functions. Reports of sterility or infertility from exposure to microwaves are questionable. No changes in the fertility of radar workers were found by Barron & Baraff (1958).

Marha et al. (1971) attributed decreased spermatogenesis, altered sex ratio of births, menstrual pattern changes, congenital effects in newborn babies, and decreased lactation to the occupational exposure of mothers to RF radiation. According to their report, such effects occurred at power densities exceeding  $10 \text{ mW/cm}^2$ .

### **8.1.3 Cardiovascular effects**

Functional damage to the cardiovascular system as manifested by hypotonus, bradycardia, delayed auricular and ventricular conductivity, and flattening of ECG waves, has been reported, by several USSR clinicians, to result from chronic exposure of workers to RF fields (Gordon, 1966, 1967; Tjagin, 1971; Baranski & Czarski, 1976). Decreases in blood pressure from exposure have also been reported. Some authors in the USSR have indicated that the nature and seriousness of cardiovascular reactions to prolonged exposure is related to changes in the nervous system, and depends on the characteristics of the individual. Some patients exhibited only

minor asthenic symptoms while others developed marked autonomic vascular dysfunction.

## **8.2 Medical Exposure**

Controlled follow-up studies of patients treated with microwave and RF diathermy could yield important data on effects, at least for partial body exposure. Such studies could not be found in the available literature. However, cases of congenital malformations ascribed to exposure to microwave or RF diathermy during early pregnancy have been found in the literature by Marha et al. (1971).

# **9. RATIONALES FOR MICROWAVE AND RF RADIATION PROTECTION STANDARDS**

## **9.1 Principles**

An important part of the rationale for standards should be the definition of the population to be protected. Occupational health standards are aimed at protecting healthy adults exposed under controlled conditions, who are aware of the occupational risk and who are likely to be subject to medical surveillance. General population standards must be based on broader considerations, including health status, special sensitivities, possible effects on the course of various diseases, as well as limitations in adaptation to environmental conditions and responses to any kind of stress in old age. As many of these considerations involve insufficiently explored interactions, standards for the general population must involve adequate safety factors, including taking into account the possibility of 24-h general population exposure compared with 8-h occupational exposure.

A distinction should be made between exposure limits for workers and equipment emission standards. The latter are based on safe operational considerations, should be derived from exposure limits, and they should not allow exposure above the adopted exposure limits. The USA performance standard for microwave ovens (US Code of Federal Regulations, 1970) may serve as an example. This standard limits the emission of unintentional radiation (microwave leakage) to  $1 \text{ mW/cm}^2$  at a distance of 5 cm from the surface

of the oven. Only a few countries have formally adopted standards. Where standards have been promulgated, the procedures of enforcement vary from regulations enforceable by law to voluntary guidelines.

Existing radiation protection guides (RPG) or exposure standards may be divided into 3 groups according to the exposure limits adopted (Czerski, 1976).

The first group comprises standards and recommendations in which microwave exposure of the order of tens of microwatts/cm<sup>2</sup> (up to 100  $\mu$ W/cm<sup>2</sup>) is allowed. The second group includes exposures of the order of hundreds of microwatts/cm<sup>2</sup> (1000  $\mu$ W/cm<sup>2</sup>), and the third group allows exposures of thousands of microwatts/cm<sup>2</sup> (10 000  $\mu$ W/cm<sup>2</sup>). This division does not correspond to any classification of RPG or exposure limits on a national or regional geographical basis. As exposure standards have been revised or introduced they have recently tended towards group 2 (Repacholi, 1978).

## 9.2 Group 1 Standards

The first group is represented by the exposure standards of Bulgaria (Bulgarian National Standard, 1979) and the USSR (Ministry of Health of the USSR, 1970; USSR Standard for Occupational Exposure, 1976; USSR Standard for Public Exposure, 1978).

The original USSR occupational microwave exposure limits were established in 1959 (Ministry of Health of the USSR, 1970). The current standard (USSR Standard for Occupational Exposure, 1976) reaffirmed the exposure limits for microwaves (300 MHz—300 GHz) and introduced exposure limits for RF (60 kHz—300 MHz). A special standard was introduced for public exposure in 1978 (USSR Standard for Public Exposure, 1978). Detailed data on exposure limits are given in Table 18 at the end of section 9.5. The exposure limits representative for this group of standards are those of the USSR occupational standard (USSR Standard for Occupational Exposure, 1976): microwave radiation (300 MHz—300 000 MHz) at working locations should not exceed 10 microwatt/cm<sup>2</sup> (0.1 W/m<sup>2</sup>) for exposure during the whole working day, 100 microwatt/cm<sup>2</sup> (1 W/m<sup>2</sup>) for exposures of not more than 2 h per working day, and 1000 microwatt/cm<sup>2</sup> (10 W/m<sup>2</sup>) for exposures of not more than 15—20 min per working day, providing that protective goggles are used and that the radiation (exposure) does not exceed 10 microwatt/cm<sup>2</sup> (0.1 W/m<sup>2</sup>) during the rest of the working day.

The principle of establishing exposure levels in standards, according to Gordon (1966, 1970), is the avoidance of risks during long-term (many years) occupational exposure.

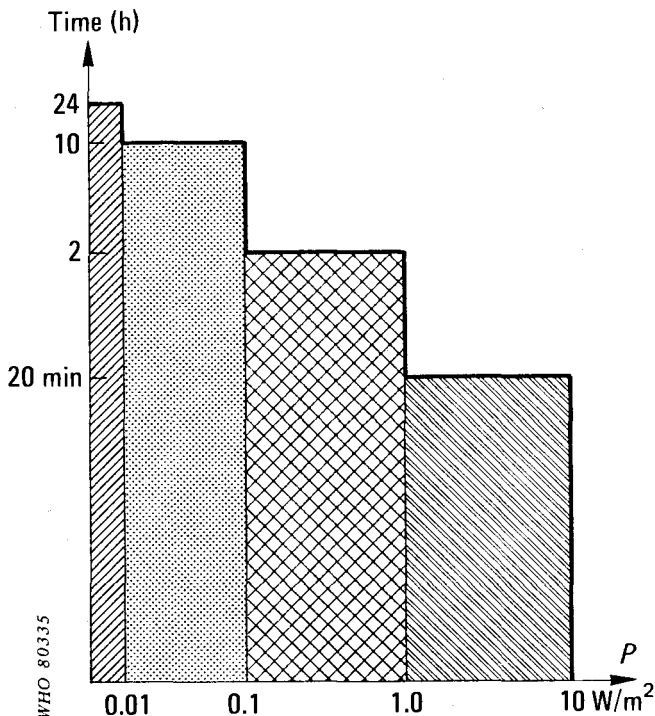

Fig. 15. Permissible limits for occupational ( $\leq 10$  h) and general public (24-h) exposure to microwave radiation (0.3–300 GHz), in the USSR.

In the USSR standard concerning general population exposure to microwaves in the range of 300 MHz–300 GHz (Fig. 15), a value of  $5 \mu\text{W}/\text{cm}^2$  has been adopted as the exposure limit over a 24-h period, for inhabited areas. This standard covers radiation from scanning and rotating antennae, which turn with a frequency below 0.5 Hz. The irradiation time of a point in space should not exceed one tenth of the scanning duty cycle, and the relation between the maximum energy levels in comparable time intervals should not exceed 10.

The USSR occupational and public health safety standards are based on the principle of complete prevention of health risks and therefore include large safety factors.

### 9.3 Group 2 Standards

The second group of standards may be illustrated by those of Czechoslovakia (Principal Hygienist of CSSR, 1965, 1970), the

German Democratic Republic Standard (GDR Standard TgL 32602/01, 1975), the Polish regulations on microwave exposure limits (Council of Ministers, 1972) and RF exposure limits (Ministers of Labour, Wages and Social Affairs and Health and Social Welfare, 1977), as well as the USA Bell Telephone recommendations (Weiss & Mumford, 1961). The recently introduced Canadian (National Health and Welfare, Canada, 1979) and Swedish (IVA-Committee, 1976; Worker Protection Authority, 1976) exposure standards and the Australian proposal (Cornelius & Vigilione, 1979) might also be placed in this group.

The Czechoslovak standard is discussed in detail by Marha et al. (1971), who claim that "biological knowledge" was taken into account in establishing the permissible exposure levels and a safety factor of 10 introduced. Ten microwatts/cm<sup>2</sup> (0.1 W/m<sup>2</sup>) mean power density was accepted as safe for long-term exposures to pulsed waves. For the "demonstrably less risky" continuous wave exposure, 25 microwatts/cm<sup>2</sup> was permitted. These rules were first adopted in 1965 and were revised in 1970 (Principal Hygienist of CSSR, 1965, 1970) in order to incorporate a time-weighted averaging procedure.

RPG values based on an 8-h working day for occupational exposure and over 24-h for the general population have also been introduced. For occupational continuous wave exposure to microwaves, the exposure limit may not exceed 25 microwatts/cm<sup>2</sup>. The permissible exposure levels are calculated according to a formula from which a continuous wave exposure to 1.6 mW/cm<sup>2</sup> or pulsed wave exposures to 0.64 mW/cm<sup>2</sup> during 1-h per working day are permissible. This is considerably higher than the values accepted in the USSR. No advice is given concerning exposure lasting for a few minutes. Details of measuring methods and equipment are also given by Marha et al. (1971). Continuous generation is defined as operation with a ratio of on-to-off time greater than 0.1. The overall impression is that the values accepted in Czechoslovakia for short periods of exposure (2 or 10 min), may be compared with those recommended by the American National Standards Institute (ANSI, 1974, 1979).

Poland adopted the same exposure limits as those of the USSR in 1961. In 1963, additional information on interpretation was introduced. Effective irradiation time was defined by the following expression for far-field exposure to intermittent radiation from scanning beams:

$$t_{ef} = (\varphi/360) t_p$$

where  $t_{ef}$  = effective irradiation time (h)

$t_p$  = time of emission of microwaves

$\varphi$  = effective beam width in degrees.

Special formulae were given for the near-field zone. Because of the difficulties of solving all the doubts arising out of practical situations, new exposure limits were subsequently proposed. These



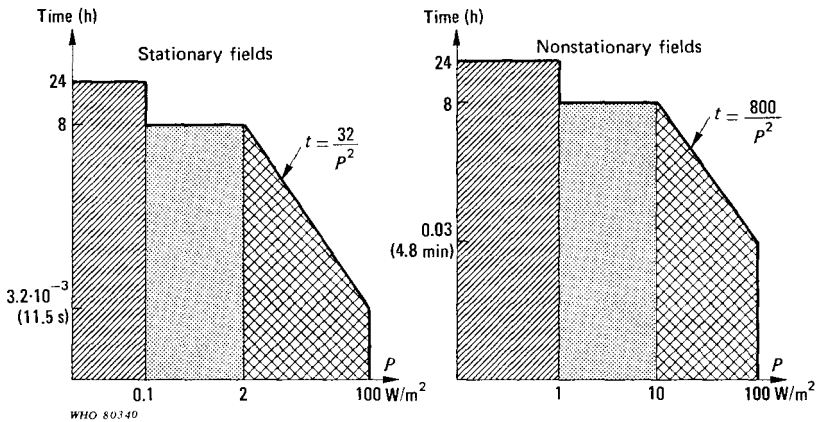

Fig. 16. Permissible limits for occupational ( $\leq 10$ -h) and general public (24-h) exposure to microwave radiation (0.3—300 GHz) in Poland.

were based on detailed discussions of findings in Czechoslovakia, the USSR and the USA, radiation protection guides, standards, and rules, and epidemiological analysis of the health status of personnel professionally exposed to microwaves (Czerski & Piotrowski, 1972). The new proposals were accepted and introduced in laws passed in Poland by the Council of Ministers (1972) and the Minister of Health and Social Welfare (1972) (Fig. 16). For the general population, the values of 10 and 100  $\mu\text{W}/\text{cm}^2$  were adopted for continuous and intermittent exposures, respectively. These values were taken as the upper limits for a safe zone, in which occupation could be unrestricted. Three other zones were defined, based on power density. For stationary (continuous) fields, these were:

(a) safe zone — the mean power density not to exceed 0.1  $\text{W}/\text{m}^2$ , human exposure unrestricted;

(b) intermediate zone — minimum value 0.1  $\text{W}/\text{m}^2$ , upper limit 2  $\text{W}/\text{m}^2$ , occupational exposure allowed during a whole working day (normally 8 h, but, in principle, could be extended to 10 h);

(c) hazardous zone — minimum value 2  $\text{W}/\text{m}^2$ , upper limit 100  $\text{W}/\text{m}^2$ , occupational exposure time per 24 h to be determined by the formula:

$$t = 32/p^2$$

where  $t$  = exposure time (h) and  $p$  = mean power density ( $\text{W}/\text{m}^2$ );

(d) dangerous zone — mean power density in excess of 100  $\text{W}/\text{m}^2$  (10  $\text{mW}/\text{cm}^2$ ), human exposure forbidden.

For exposures to non-stationary fields, i.e., intermittent exposure, the following values were adopted:

(a) safe zone — mean power density not to exceed 1  $\text{W}/\text{m}^2$  (0.1  $\text{mW}/\text{cm}^2$ );

(b) intermediate zone — minimum value  $1 \text{ W/m}^2$ , upper limit  $10 \text{ W/m}^2$ , occupational exposure allowed during a whole working day, as defined earlier;

(c) hazardous zone — minimum value  $10 \text{ W/m}^2$ , upper limit  $100 \text{ W/m}^2$ , the professional exposure time per 24 h to be determined by the formula:

$$t = 800/p^2$$

where  $t$  = exposure time (h) and  $p$  = mean power density ( $\text{W/m}^2$ );

(d) dangerous zone — mean power density in excess of  $100 \text{ W/m}^2$  ( $10 \text{ mW/cm}^2$ ), human exposure forbidden.

The Polish law (Council of Ministers, 1972) names the bodies to be responsible for health surveillance, supervision of working conditions, and the manner of carrying out the measurements (in principle, every 3 years, and after changes in equipment or its displacement). The main responsibility for decisions on admissibility of working conditions rests with the sanitary epidemiological stations of the Public Health Service. Newly designed equipment must be evaluated by the Ministry of Health and Social Welfare, before production and/or installation is allowed. For installation of microwave equipment, permission is required from the sanitary epidemiological station of the province.

These Polish regulations, in common with those of Czechoslovakia and the USSR, have the following characteristics:

(a) Exposure limits determined separately for occupational and general population exposures, medical examinations of microwave workers limit occupationally exposed population to healthy adults only;

(b) unified methods of measurement, measuring equipment, and evaluation of results for health purposes;

(c) unified methods of medical examinations and evaluation of the results obtained;

(d) determination of responsibility for compliance with RPG.

Sweden has introduced regulations for occupational exposure with  $1 \text{ mW/cm}^2$  as the normal limit for microwave exposure and allows short-term excursions to a maximum of  $25 \text{ mW/cm}^2$ . In the range 10—300 MHz, the limits are  $5 \text{ mW/cm}^2$  and  $25 \text{ mW/cm}^2$  (IVA Committee, 1976; Workers Protection Authority, 1976).

A new Canadian standard has now been published (National Health and Welfare, Canada, 1979). This standard was developed following an in-depth scientific evaluation of the literature (National Health and Welfare, Canada, 1977, 1978) and was proposed (Repacholi, 1978) as a draft so that it could be extensively reviewed. The final standard applies to both occupational exposure and exposure of the general population. Table 17 summarizes the exposure limits for whole or partial body exposure to either continuous or modulated electromagnetic radiation in the frequency range 10 MHz—300 GHz.

Table 17. Canadian exposure limits for whole or partial body exposure continuous or intermittent radiation from 10 MHz—300 GHz<sup>a</sup>

Group	Frequency range	Exposure limits
General population	10 MHz—300 GHz	1 mW/cm <sup>2</sup> 60 V/m 0.16 A/m Averaged over 1 min
Occupational	10 MHz—1 GHz	1 mW/cm <sup>2</sup> 60 V/m 0.16 A/m Averaged over 1 h
	1 GHz—300 GHz	5 mW/cm <sup>2</sup> 140 V/m 0.36 A/m Averaged over 1 h

<sup>a</sup> From: National Health and Welfare, Canada (1979).

Higher occupational exposure is permitted for periods of less than 1 h. However, the maximum power density, averaged over a 1-min period should not exceed 25 mW/cm<sup>2</sup>. Fig. 17 shows the permitted occupational exposure in Canada.

Recently, the Australian Radiation Laboratory published a draft proposal (Cornelius & Viglione, 1979) for exposure limits in the range of 10 MHz—300 GHz. The values proposed are shown in

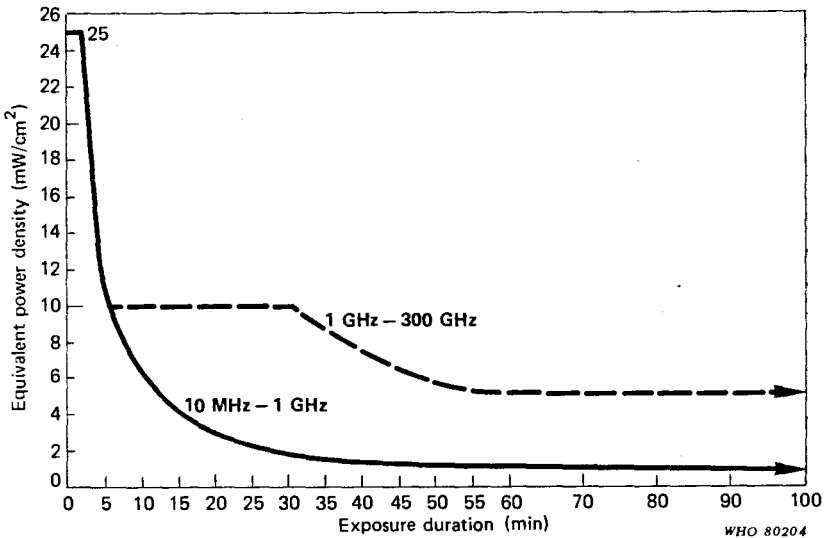

Fig. 17. Occupational exposure limits for workers exposed to microwaves in the frequency range 10 MHz—300 GHz (From: National Health and Welfare, Canada, 1979).

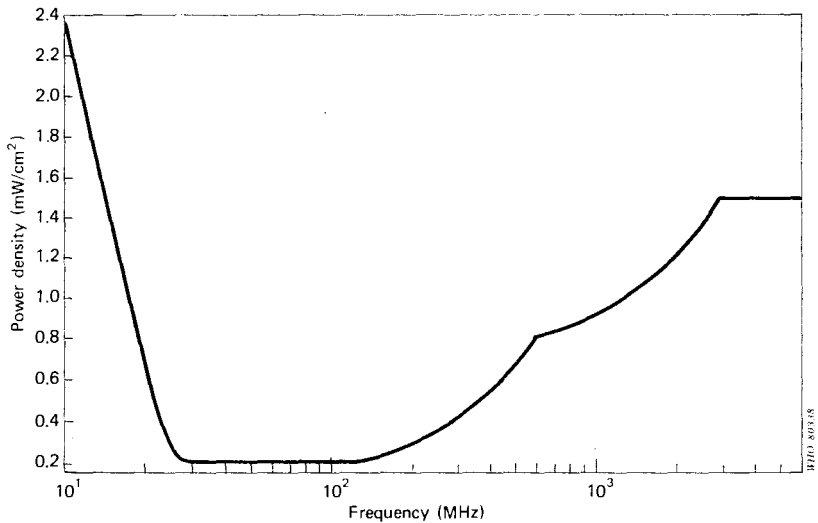

Fig. 18. Maximum permissible exposure limits according to an Australian draft proposal (From: Cornelius & Viglione, 1979).

Fig. 18 and, according to the authors, are the result of a “worst case analysis”. Although, the rationale and some of the calculations presented in this paper may be questioned on a formal basis, it is interesting to note that the values for exposure limits agree well with those of the group 2 of standards.

#### 9.4 Group 3 Standards

The third group of standards may be illustrated by the 1966 US Army regulations (Polmisans & Peczenik, 1966), The American National Standards Institute Standard (ANSI, 1966) and recommendations of the American Conference of Governmental Industrial Hygienists (ACGIH, 1971, 1979). Fig. 19 presents a comparison of these standards with the Bell Telephone recommendations (Weiss & Mumford, 1961).

The US Army Standard is obviously intended as an occupational safety RPG to microwaves and RF. Unlimited exposure is allowed at levels below 10 mW/cm<sup>2</sup> but exposure at power densities higher than 100 mW/cm<sup>2</sup> is considered dangerous. Within the range of 10—100 mW/cm<sup>2</sup>, exposure is allowed for a limited time according to the formula:

$$t = 6000/P_d^2$$

where  $t$  = exposure time (min) and  
 $P_d$  = mean power density (mW/cm<sup>2</sup>).

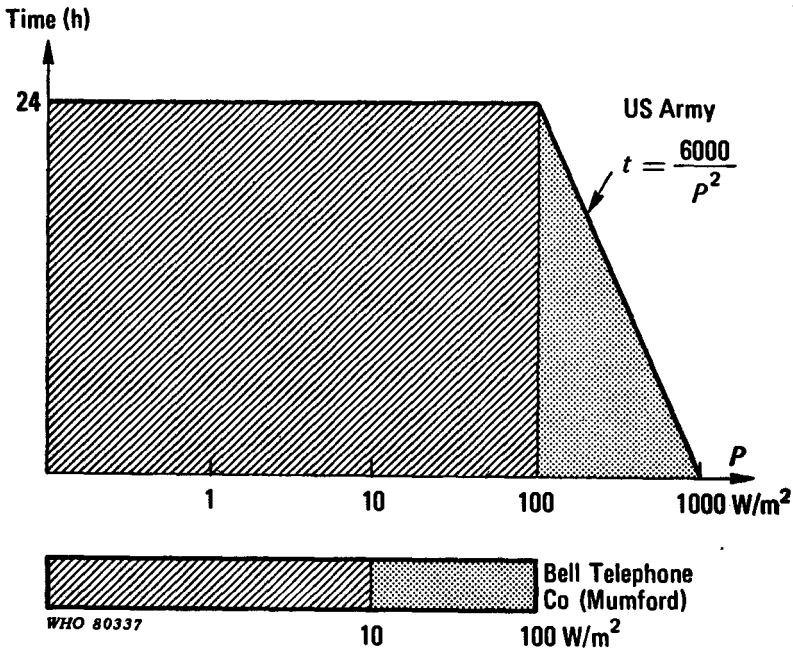

Practical values: min per 1 h		$P$ W/m <sup>2</sup>
Army	2	350
	6	320
US ANSI	1	600
	6	100
ACGIH (8 h)		100
250 W/m <sup>2</sup> ceiling value	10	100 - 250

Fig. 19. Comparison of some of the exposure limits proposed in the USA (see also Table 18).

A practical upper limit of 55 mW/cm<sup>2</sup> is imposed, based on the assumption that exposure of less than 2 min duration cannot be properly regulated.

It is also recommended that, wherever possible, exposure levels inside military installations should be reduced to a minimum.

The recommendations drawn up by the C-95.1 Committee of the American National Standards Institute do not set an upper limit of exposure (ANSI, 1966). However, this limit is defined indirectly by the recommendation that the power density to which people may be exposed should not exceed 10 mW/cm<sup>2</sup> as averaged over

any period of 0.1 h. No distinction between pulsed or continuous wave exposure is made. These recommendations allow a 1-min exposure to  $60 \text{ mW/cm}^2$ , which may be repeated 10 times per hour. US Army recommendations allow only a single 2-min exposure at  $55 \text{ mW/cm}^2$  during 1 h. On the other hand, ANSI recommendations allow a 6-min exposure at only  $10 \text{ mW/cm}^2$ , while the US Army accepts  $32 \text{ mW/cm}^2$  for this period.

The ANSI C.95.1 Committee revised its standard in 1974 (ANSI 1974) and is considering a draft proposal to reduce the permissible exposure limits (ANSI, 1979). A comparison of the ANSI exposure limits in successive standards can be found in Table 18 at the end of this section.

The American Conference of Governmental Industrial Hygienists has also made recommendations for the frequencies of 300 MHz—300 GHz (ACGIH, 1971, 1979, 1980):

(a) For average power density levels up to, but not exceeding  $10 \text{ mW/cm}^2$ , total exposure time should be limited to the 8-h working day (continuous exposure).

(b) Exposure to higher average power density levels is permitted for short periods of time. For example, exposure to  $25 \text{ mW/cm}^2$  is permitted for 2.4 min during each 6-min period in an 8-h working day (intermittent exposure);

(c) For average power density levels exceeding  $25 \text{ mW/cm}^2$ , no exposure is permissible (ceiling value).

(d) Under conditions of moderate to severe heat stress, the values recommended may need to be reduced.

These Group 3 recommendations are based on human thermal balance characteristics contained in the studies by Schwan & Piersol (Schwan, 1978; Schwan & Piersol, 1954, 1955) on the biophysical and physiological aspects of the absorption of electromagnetic energy in body tissues. These views (Schwan, 1976) can be presented briefly as follows:

(a) the principal effects of microwaves consist of temperature increases in the irradiated object;

(b) because of heat balance characteristics in man, indefinite exposure to  $10 \text{ mW/cm}^2$  is possible, higher values may be accepted for short-term exposure;

(c) the formation of cataracts or lenticular opacities cannot be expected at power densities below  $100 \text{ mW/cm}^2$ ;

(d) biophysical considerations exclude the possibility of microwave interaction with nerve cells;

(e) there is no evidence of untoward effects of microwave radiation in man at power densities below  $10 \text{ mW/cm}^2$ .

The US ANSI Committee is in the process of revising its standard and it appears likely from review documents, which have been circulated, that the  $10 \text{ mW/cm}^2$  value will be reduced to  $1 \text{ mW/cm}^2$  in the frequency range 30—300 MHz with increased levels on

either side of this frequency range (ANSI, 1979). This standard would then come in Group 2.

### 9.5 RF Radiation Standards (100 kHz to 300 MHz)

The USA exposure limits covering the range 10 MHz—100 GHz and some other national standards (e.g., the United Kingdom) include a part of the RF range. Standards intended specifically for RF radiation (as defined by international agreement), have been introduced only in Czechoslovakia (Principal Hygienist of CSSR, 1965, 1970), the German Democratic Republic (GDR Standard — TGL 32602, 1973), Poland (Ministers of Labour, Wages and Social Affairs and of Health and Social Welfare, 1977), and in the USSR (USSR Standard for Occupational Exposure GOST 12.1.00.76, 1976; USSR Standard for Public Exposure SN-1823-78, 1978).

In the USSR occupational standard, values from 5 V/m to 50 V/m have been adopted in the range of 60 kHz to 300 MHz (see Table 18). The USSR values for inhabited areas (public health standards) are as follows:

	E field
in the range of 30—300 kHz	20 V/m
in the range of 0.3— 3 MHz	10 V/m
in the range of 3— 30 MHz	4 V/m
in the range of 30—300 MHz	2 V/m

In the Czechoslovak standard (Marha et al., 1971), the approach to RF exposure is similar to that for microwave exposure. The permissible exposure duration for the frequency range 30 kHz—30 MHz is calculated from the formula:

$$E \times t = 120$$

where  $E$  = peak electric field strength (V/m)

$t$  = time (h)

For 24-h exposure, 5 V/m is considered safe. In the range of 30 MHz—300 MHz, the equivalent is 1 V/m.

Occupational exposure guide values are: 400 for 40 kHz—30 MHz and 80 for the range 30 MHz—300 MHz allowing 50 V/m and 10 V/m, respectively, for an 8-h working day.

The Polish proposal uses the concept of 4 zones, i.e., safe, intermediate, hazardous, and dangerous, and exposure limits presented in Fig. 20 and 21 are of the same order of magnitude as those for Czechoslovakia and the USSR.

Table 18 includes examples of microwave and RF exposure limits adopted or proposed by various countries.

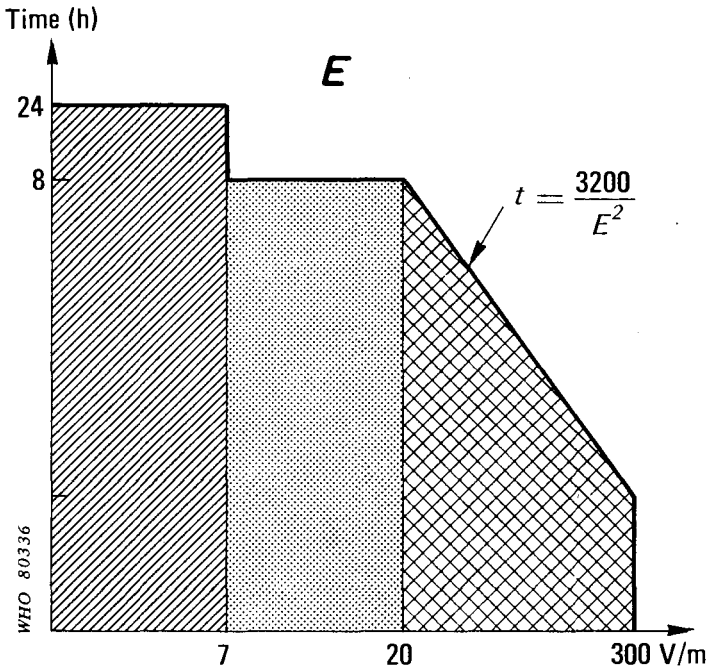

Fig. 20. Permissible limits for occupational ( $\leq 10$ -h) and general public (24-h) exposure to radiofrequency radiation (10–300 MHz) in Poland.

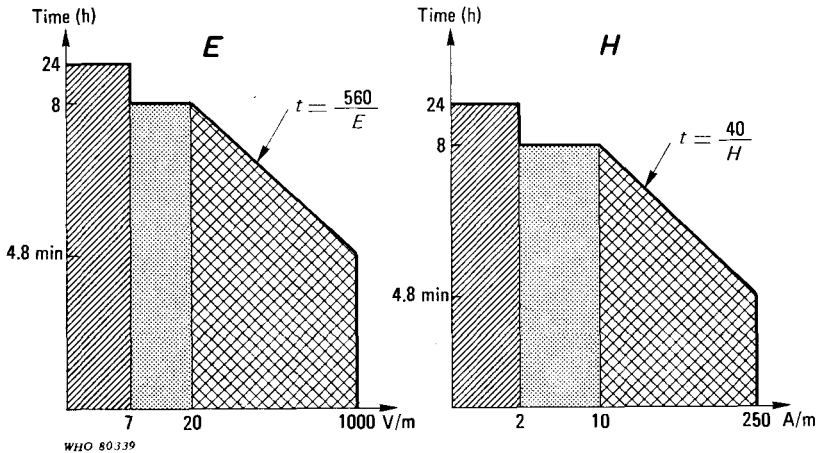

Fig. 21. Permissible limits for occupational ( $\leq 10$ -h) and general public (24-h) exposure to radiofrequency radiation (0.1–10 MHz) in Poland.



Table 18. Examples of microwave and RF exposure limits in various countries

Country, agency, or organization, date	Type of standard	Frequency	Exposure limit	Exposure duration	cw/pulsed	Antenna stationary/rotating	Remarks
<b>Australia</b> Australian Radiation Laboratory (Cornelius & Vigilione, 1979)	Draft proposal for both occupational and public exposure		Frequency ( <i>f</i> ) MHz dependent limit (L) mWh/cm <sup>2</sup> for time integrated exposures averaged over any 1-h period and 4 (L) mW/cm <sup>2</sup> averaged over any 1-s period for periods of less than 1 h $L = 5.4 - 0.365 f + 0.0064 f^2$ $L = 0.2$ $L = 0.2 + 0.00128 (f - 130)$ $L = 0.8 + 0.00029 (f - 600)$ $L = k.5$	24 h	both	both	Compare Fig. 18; a proposal for near-field exposure limits is also included, peak pulse exposure is limited to 1 W/cm <sup>2</sup> .
<b>Bulgaria</b> State (National) Committee for Standardization (1979)	Legal national standards; enforceable by law; occupational	60 kHz—3 MHz 3 MHz—30 MHz 30 MHz—50 MHz 50 MHz—300 MHz  60 kHz—1.5 MHz 30 MHz—50 MHz  300 MHz—300 GHz 300 MHz—300 GHz  300 MHz—300 GHz 300 MHz—300 GHz	Electric field strength V/m 50 V/m 20 V/m 10 V/m 5 V/m Magnetic field strength A/m 5 A/m 0.3 A/m Power density W/m <sup>2</sup> up to 0.1 0.1—1 W/m <sup>2</sup>  1.0—10.0 W/m <sup>2</sup>  up to 1.0 W/m <sup>2</sup> 1.0—10.0 W/m <sup>2</sup>	working day working day working day working day working day working day working day working day working day no more than 2 h  no more than 20 min  working day no more than 2 h	—       both both  both both	—       stationary stationary  stationary rotating rotating	Up to 0.1 during the remainder of the working day. Up to 0.1 during the remainder of the working day — protective goggles required.  If the ambient temperature is over 28 °C or simultaneous exposure to X-rays occurs, exposures over 1.0 W/m <sup>2</sup> are not allowed.

Table 18 (contd)

96

Country, agency, or organization, date	Type of standard	Frequency	Exposure limit	Exposure duration	cw/pulsed	Antenna stationary/rotating	Remarks
<b>Canada</b> Canadian Standards Association (1966)	Voluntary, occupational	10 MHz—100 GHz	10 mW/cm <sup>2</sup>	no limit	cw	both	No longer applies, as the 1979 national standard is more conservative.
National Health & Welfare (1979)	National health and occupational safety regulation, enforceable by law.		1 mWh/cm <sup>2</sup>	0.1 h	pulsed	both	
	Occupational	10 MHz—1 GHz	1 mW/cm <sup>2</sup> power density 60 V/m rms electric field strength 0.16 A/m rms magnetic field strength	no limit averaged over 1 h	both	both	See also Fig. 17.
		1 GHz—300 GHz	5 mW/cm <sup>2</sup> power density 140 V/m rms electric field strength 0.36 A/m rms magnetic field strength	averaged over 1 h	both	both	
		10 MHz—300 GHz	25 mW/cm <sup>2</sup> power density 300 V/m rms electric field strength 0.8 A/m rms magnetic field strength	1 min	both	both	These values cannot be exceeded and constitute "ceiling levels". Some provisions for "special" cases, under strictly controlled conditions were added. 10 mW/cm <sup>2</sup> cannot be exceeded when averaged over 1-h period.
	General population	10 MHz—300 GHz	1 mW/cm <sup>2</sup> power density 60 V/m rms electric field strength 0.16 A/m rms magnetic field strength	no limit, averaged over 1 min			
<b>Czechoslovakia</b> Principal Hygienist of the CSSR (1970)	National health and occupational safety regulation enforceable by law.						

Occupational	30 kHz—30 MHz	Exposure limit (L) V/m calculated according to formula: $L \times t$ (h) = 400, i.e., 50 V/m for 8 h	Exposure duration (t) in hours calculated according to the formula in the next column to the left	—	—	Occupationally exposed persons are under obligatory medical surveillance (periodical examinations as specified by law). Unified measuring methods are imposed and specified by the same regulations. The regulations dated 1965 limited peak pulse power (instantaneous exposure) to 1 kW/cm <sup>2</sup> . This was omitted in the revision dated 1970.	
	30 MHz—300 MHz	$L \times t$ (h) = 80, i.e., 10 V/m for 8 h					
	300 MHz—300 GHz	Exposure limit (L) $\mu$ W/cm <sup>2</sup> calculated according to formula $L \times t$ (h) = 200 i.e., 25 $\mu$ W/cm <sup>2</sup> for 8 h	as above	cw	both		
	300 MHz—300 GHz	$L \times t$ (h) = 80, i.e., 10 $\mu$ W/cm <sup>2</sup> for 8 h	as above	pulsed	both		
	General population	30 kHz—30 MHz	Exposure limit (L) V/m calculated according to formula $L \times t$ (h) = 120, i.e., 5 V/m for 24 h	as above	—		—
		30 MHz—300 MHz	Exposure limit (L) V/m calculated according to the formula $L \times t$ (h) = 24, i.e., 1 V/m for 24 h	as above	—		—
		300 MHz—300 GHz	Exposure limit (L) $\mu$ W/cm <sup>2</sup> calculated according to the formula $L \times t$ (h) = 60, i.e., 2.5 $\mu$ W/cm <sup>2</sup> for 24 h	as above	cw		both
300 MHz—300 GHz		$L \times t$ (h) = 24, i.e., 1 $\mu$ W/cm <sup>2</sup> for 24 h	as above	pulsed	both		

*German Democratic Republic*

National Committee for Standardization, Measurements and Products Control (1975)	National occupational health standards, enforceable by law	60 kHz—3 MHz	50 V/m electric field strength	working day	—	—	Supersedes a standard dated 1972, microwave exposure limits did not change, RF exposure limits were introduced by the new version.
		3 MHz—30 MHz	20 V/m electric field strength	working day	—	—	
		30 MHz—50 MHz	10 V/m electric field strength	working day	—	—	
		50 MHz—300 MHz	5 V/m electric field strength	working day	—	—	
		300 MHz—300 GHz	10 $\mu$ W/cm <sup>2</sup> power density	up to 8 h	both	stationary	
		300 MHz—300 GHz	100 $\mu$ W/cm <sup>2</sup> power density	up to 2 h	both	stationary	
		300 MHz—300 GHz	1000 $\mu$ W/cm <sup>2</sup> power density	up to 20 min	both	stationary	
		300 MHz—300 GHz	100 $\mu$ W/cm <sup>2</sup> power density	up to 8 h	both	rotating	
300 MHz—300 GHz	1000 $\mu$ W/cm <sup>2</sup> power density	up to 2 h	both	rotating			

1000  $\mu$ W/cm<sup>2</sup> is a "ceiling level" that cannot be exceeded.

*Potana*

Council of Ministers (1972)

National regulation, enforceable by law

300 MHz—300 GHz	up to 0.1 W/m <sup>2</sup> (safe zone)	unlimited (implicit general public)	both	stationary
-----------------	--	-------------------------------------	------	------------

Supersedes a 1961 regulation establishing essentially the same exposure

Country, agency, or organization, date	Type of standard	Frequency	Exposure limit	Exposure duration	cw/pulsed	Antenna stationary/rotating	Remarks
		300 MHz—300 GHz	0.1 W/m <sup>2</sup> —2 W/m <sup>2</sup> (intermediate zone)	working day	both	stationary	limits, as those in the USSR. Although an occupational standard, it established a "safe" zone, within which human occupancy is unrestricted. Only workers (persons occupationally exposed) having a medical certificate of fitness and subject to periodic medical examinations may enter the "intermediate" and "hazardous" zones. In this way an implicit general population exposure limit has been established. A regulation establishing general public and environmental protection exposure limits for microwave, RF, and ELF was drafted and will be adopted in 1980. Compare Fig. 16 and section 9.3. Occupational exposure durations and definitions of electromagnetic fields, stationary versus rotating antennae, determined by a separate regulation (Minister of Health & Social Welfare, 1972). P = power density W/m <sup>2</sup> .
		300 MHz—300 GHz	2 W/m <sup>2</sup> —100 W/m <sup>2</sup> (hazardous zone)	$\frac{32}{P}$ hours	both	stationary	
		300 MHz—300 GHz	Exceeding 100 W/m <sup>2</sup> (danger zone)	human occupancy prohibited (ceiling level)	both	stationary	
		300 MHz—300 GHz	up to 1 W/m <sup>2</sup> (safe zone)	unlimited (implicit general public)	both	rotating	
		300 MHz—300 GHz	1 W/m <sup>2</sup> —10 W/m <sup>2</sup> (intermediate zone)	working day	both	rotating	
		300 MHz—300 GHz	10 W/m <sup>2</sup> —100 W/m <sup>2</sup> (hazardous zone)	$\frac{800}{P}$ hours	both	rotating	
		300 MHz—300 GHz	Exceeding 100 W/m <sup>2</sup> (danger zone)	human occupancy prohibited (ceiling level)	both	rotating	
The Ministers of Labour, Wages and Social Affairs	National regulation enforceable by law	0.1 MHz—10 MHz	20 V/m rms electric field strength (safe zone)	unlimited (implicit general population)	—	—	The same concept of safe, intermediate, hazardous, & danger zones makes the

and of Health  
and Social  
Welfare (1977)

		20 V/m—70 V/m rms electric field strength (intermediate zone)	working day	both	—	
		70 V/m—1000 V/m rms electric field strength (hazardous zone)	$\frac{560}{E}$	both	rotating	
		Exceeding 1000 V/m rms electric field strength (danger zone)	human occupancy prohibited (ceiling level)	both	rotating	
		up to 7 V/m rms electric field strength (safe zone)	unlimited (implicit general population)	both	rotating	
10 MHz—300 MHz		7 V/m—20 V/m rms electric field strength (intermediate zone)	working day			
		20 V/m—300 V/m rms electric field strength (hazardous zone)	$\frac{3200}{E^2}$	both	rotating	
		Exceeding 300 V/m rms electric field strength (danger zone)	human occupancy prohibited (ceiling level)	both	rotating	

standard an implicit general population one. Within the 0.1—10 MHz range, rms magnetic field strength values were given but, as they exceed corresponding rms electric field values, only these are used in practice, as the limiting factor in permissible exposure values. Compare Fig. 21 and Fig. 22. E = rms electric field strength.

Sweden  
Workers  
Protection  
Authority  
(1976)

National occupational safety regulation

10—300 MHz	5 mW/cm <sup>2</sup>	8 h	both	rotating	
0.3—300 GHz	1 mW/cm <sup>2</sup>	8 h			
0.3—300 GHz	1—25 mW/cm <sup>2</sup>	$\frac{60}{P}$	both	rotating	
10 MHz—300 GHz	25 mW/cm <sup>2</sup>	averaged over	both	rotating	

P = power density mW/cm<sup>2</sup>.  
Ceiling level.

USA  
American  
National  
Standards  
Institute  
(ANSI)  
(1966)

Occupational voluntary consensus standard (recommendation)

10 MHz—300 GHz	10 mW/cm <sup>2</sup>	no limit (for periods of 0.1 h or more)	both	both	
	1 mW/cm <sup>2</sup>	during any 0.1-h period	both	both	

Under "moderate environmental" conditions, people with circulatory difficulties and certain other ailments are more vulnerable. Techniques and instrumentation for measurements are given in ANSI-C95.3-1973 publication. Prevention of associated hazards — see Institute of Makers of Explosives (1971).

ANSI (1974)

Occupational voluntary consensus standard (recommendation)

10 MHz—300 GHz	10 mW/cm <sup>2</sup> power density 200 V/m electric field strength 0.5 A/m magnetic field strength	no limit	cw	both	
----------------	---	----------	----	------	--

Table 18 (contd).

Country, agency, or organization, date	Type of standard	Frequency	Exposure limit	Exposure duration	cw/pulsed	Antenna stationary/rotating	Remarks
			10 mW/cm <sup>2</sup> power density 1 mWh/cm <sup>2</sup> energy density 40 000 V <sup>2</sup> /m <sup>2</sup> mean squared electric field strength (E <sup>2</sup> ) 0.25 A <sup>2</sup> /m <sup>2</sup> mean squared magnetic field strength (A <sup>2</sup> )	0.1 h	pulsed	both	The US Department of Labour adopted the ANSI 1968 standard in its proposed rules (Fed. Register, Vol. 38, No. 166, para 1910, 345, p. 23046, 1973) and finally adopted 10 mW/cm <sup>2</sup> as maximum safe exposure limit for occupational exposure (Fed. Register, Vol. 40, No. 59, point 12, p. 13138, 1975). This standard is a recommendation and the Dept of Labour is preparing a new standard.
ANSI (1979)	Draft proposal for voluntary consensus standard (recommendation)	0.3—3 MHz	100 mW/cm <sup>2</sup> power density 400 000 V <sup>2</sup> /m <sup>2</sup> —E <sup>2</sup> 2.5 A <sup>2</sup> /m <sup>2</sup> —H <sup>2</sup>	no limit, averaged over any 0.1-h period	both	both	Mean squared electric field strength (E <sup>2</sup> ) and mean squared magnetic field strength (H <sup>2</sup> ) are applicable to near-field exposures. f is the frequency in MHz.
		3—30 MHz	900 mW/cm <sup>2</sup> — power f <sup>2</sup> — density $\frac{4000 \times 900}{f^2} \text{V}^2/\text{m}^2 \text{—} E^2$ $\frac{0.025 \times 900}{f^2} \text{A}^2/\text{m}^2 \text{—} H^2$	averaged over any 0.1-h period	both	both	
		30—300 MHz	1.0 mW/cm <sup>2</sup> power density 4000 V <sup>2</sup> /m <sup>2</sup> —E <sup>2</sup> 0.025 A <sup>2</sup> /m <sup>2</sup> —H <sup>2</sup>	averaged over any 0.1-h period	both	both	
		0.3—1.5 GHz	$\frac{f}{300} \text{mW/cm}^2$ $\frac{4000 \times f}{300} \text{V}^2/\text{m}^2 \text{—} E^2$ $\frac{0.025 \times f}{300} \text{A}^2/\text{m}^2 \text{—} H^2$	averaged over any 0.1-h period	both	both	

		1.5—300 GHz	5 mW/cm <sup>2</sup> power density 20000 V <sup>2</sup> /m <sup>2</sup> —E <sup>2</sup> 0.125 A <sup>2</sup> /m <sup>2</sup> —H <sup>2</sup>	averaged over any 0.1-h period	both	both	
American Conference of Govern- mental Industrial Hygienists (ACGIH) (1979)	Recommen- dation	10 MHz—100 GHz	Same as ANSI (1974)	same as ANSI (1974)	both	both	A ceiling level of 25 mW/cm <sup>2</sup> was added to ANSI (1974) re- commendations. <i>Note:</i> A legally en- forceable USA stan- dard is an equipment emission standard for microwave ovens (US Code of Federal Regulations, 1970).
<i>USSR</i>							
National Standards Committee at the Council of Ministers of the USSR, 1976 (USSR Standard for Occupational Exposure, 1976)	Occupational national stan- dard, enforce- able by law	60 kHz—3 MHz 3 MHz—30 MHz 30 MHz—50 MHz 50 MHz—300 MHz 60 kHz—1.5 MHz	50 V/m electric field strength 20 V/m electric field strength 10 V/m electric field strength 5 V/m electric field strength	working day	both	both	Supersedes earlier regulations and stan- dards (section 9.2) without essential changes.
		60 kHz—1.5 MHz	5 A/m magnetic field strength	working day	both	both	
		30 MHz—50 MHz	0.3 A/m magnetic field strength	working day	both	both	
		300 MHz—300 GHz	up to 0.1 W/m <sup>2</sup> power density 0.1 to 1.0 W/m <sup>2</sup> power density	working day up to 2 h per day	both both	stationary stationary	During the remainder of the working day up to 0.1 W/m <sup>2</sup> .
		300 MHz—300 GHz	1.0 to 10 W/m <sup>2</sup> power density	up to 20 min per day	both	stationary	During the remainder of the working day up to 0.1 W/m <sup>2</sup> , pro- tective goggles are required.
		300 MHz—300 GHz	up to 1.0 W/m <sup>2</sup> power density	during the working day	both	rotating	
			1.0 to 10 W/m <sup>2</sup> power density	up to 2 h per day	both	rotating	During the remainder of the working day up to 1.0 W/m <sup>2</sup> .
Ministry of Health Pro- tection (USSR Public Health Standard, 1978) (1978)	Public health regulation enforceable by law	see section 9.2					

## **10. SAFETY PROCEDURES FOR OCCUPATIONALLY EXPOSED PERSONNEL**

Broadcasting, radio, radar, industrial heating, and medical equipment are essentially the same in all countries. Thus, the field strengths associated with different types of equipment will be similar and typical examples are shown in Fig. 22. In many instances, much higher field strengths may be encountered. Where personnel may be exposed to potentially high field strengths, they should receive appropriate training and be made aware of possible risks to health from the improper use of the equipment. This is especially important where the operation of equipment does not necessitate professional training or skills, e.g., plastic sealers. It is likely that service work or repairs will entail greater risk than operation since protective devices such as screens and interlocks would, in many cases, have to be rendered inoperable to carry out the servicing or repairs. Furthermore, service or repair personnel would generally be closer to the microwave/RF source.

Reviews of safety procedures can be found in Mumford (1961), ANSI (1973), Minin (1974), Krylov & Jucenkova (1979), and National Health & Welfare, Canada (1979) (Safety Code 6).

### **10.1 Procedures for Reducing Occupational Exposure**

The basic methods of controlling and limiting microwave/RF exposure, in order of desirability are: (a) engineering — safe design and construction; (b) siting; (c) administrative; and (d) personnel protection.

All unnecessary emissions should be minimized at the source, preferably by containment or otherwise effective screening. This approach is clearly impractical as far as the antenna system of deliberate emitters is concerned. In this case, siting can be very important in keeping both the number of people, who may be exposed, and the levels of exposure as low as possible. The same considerations apply where emission is unintentional but some leakage is unavoidable.

Where people can be exposed to potentially hazardous levels, access to such areas should be controlled and restricted to persons who are trained and are aware of any risks. The use of special warning signs described in the Health and Welfare Canada Safety Code 6 (National Health and Welfare, Canada, 1979) would be particularly useful. Time spent in the area should be kept as short as possible and, wherever practicable, microwave/RF power levels should be kept as low as readily achievable.



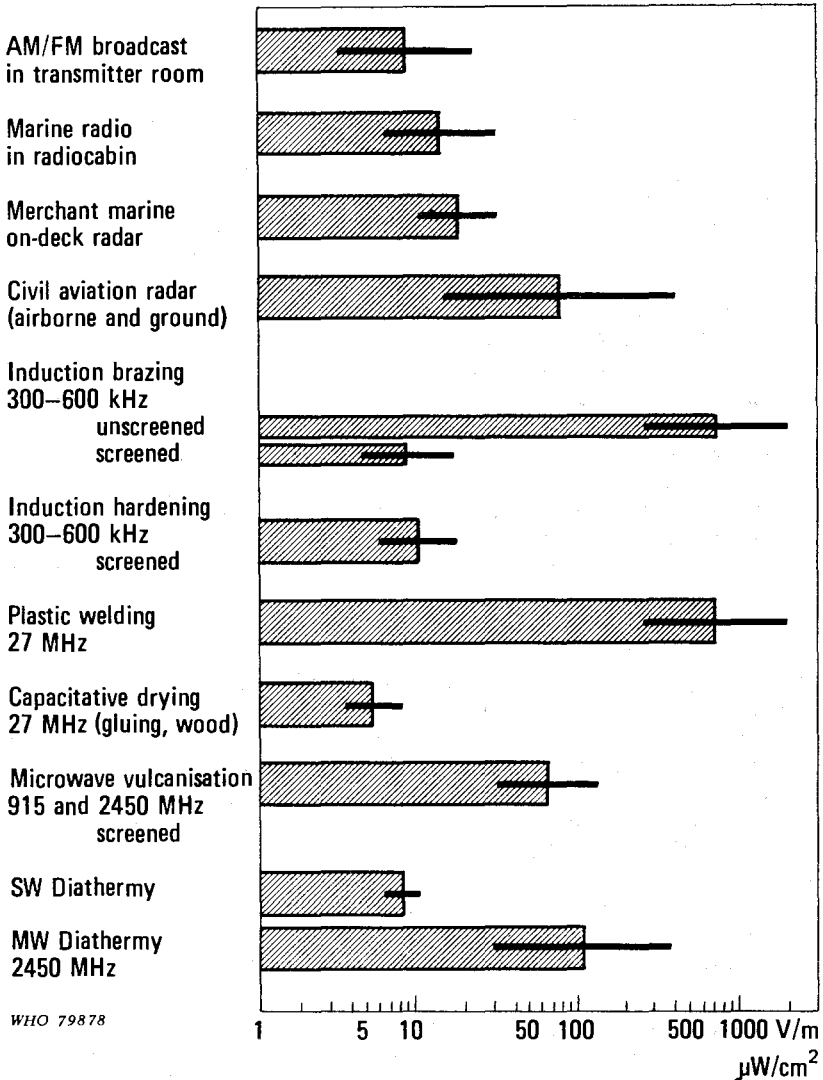

Fig. 22. Field strengths typically occurring in the vicinity of industrial equipment and work places.

The use of protective clothing is not generally recommended as it may initiate other hazards to the wearer, e.g., RF burns.

For more detailed information, the reader is referred to the Health and Welfare Canada Safety Code 6 (National Health and Welfare, Canada, 1979).

## 11. ASSESSMENT OF DATA ON BIOLOGICAL EFFECTS AND RECOMMENDED EXPOSURE LIMITS

Major difficulties exist in assessing the potential health hazards to man of exposure to microwave and RF radiation, because of the highly complex relationship between the exposure conditions and the energy absorbed. The absorbed dose and rate of energy absorption depend critically on such variables as frequency, power density, field polarization, the size and shape of the exposed subject, and environmental factors. Many of the experiments contain insufficient information on the dosimetry, thus, difficulties arise in the exact interpretation of results.

Experimental results indicate that most reported effects can be explained on the basis of microwave-induced, nonuniform heating. However, other investigations which have been carried out to evaluate the mechanisms involved, e.g., comparison of effects induced by microwaves with those produced by a water bath, indicate that nonthermal mechanisms may be involved. Further thorough studies of these nonthermal mechanisms are necessary, as their contribution to the understanding of microwave effects may be of great importance.

Since most biological effects have been reported as phenomena, little information exists on quantitated dose-effect relationships. Studies on dose-effect threshold levels and their frequency dependence are badly needed in most areas. Because of the lack of such data, recommendations for exposure limits can only be made on the best available interpretations of the literature. Such interpretations also require an assessment of whether effects reported as phenomena truly present a hazard to health. Many effects are transient or easily reversible while others may cause permanent damage.

From the summaries in sections 7 and 8, the following recommendations can be made:

- (a) Effects have been reported at power densities too low to produce biologically significant heating.
- (b) The occupationally-exposed population consists of healthy adults exposed under controlled conditions, who are aware of the occupational risk. The exposure of this population should be monitored.

It is possible to indicate exposure limits from available information on biological effects, health effects, and risk evaluation. For workers, whole or partial body exposure to continuous or pulsed microwaves or RF radiation having average power densities within the range 0.1—1 mW/cm<sup>2</sup> includes a high enough safety factor to allow continuous exposure to microwaves/RF from any part of the frequency range, over the whole working day. Higher exposure may be permissible over part of the frequency range and for inter-

mittent or occasional exposure. Special considerations may be indicated in the case of pregnant women.

(c) The general population includes persons of different ages (infants, small children, young adults and senior citizens) and different states of health, including pregnant women. The possible greater susceptibility of the developing fetus to microwave/RF exposure may deserve special consideration. Exposure of the general population should be kept as low as possible and limits should generally be lower than those for occupational exposure.

In view of the fact that data are still required to clarify interaction mechanisms and determine threshold levels for effects, it is recommended that microwave and RF exposure of occupationally-exposed workers and the general population should be kept as low as readily achievable.

More precise exposure limits over the frequency range 100 kHz—300 GHz for both occupational and general population exposure to microwaves/RF will be recommended in follow-up documents.

## REFERENCES

- ACGIH (1971) *Threshold limit values of physical factors with intended changes adopted by ACGIH for 1971*, Cincinnati, OH, American Conference of Governmental Industrial Hygienists.
- ACGIH (1979) *Threshold limit values documentation; Microwaves*. Cincinnati, OH, American Conference of Governmental Industrial Hygienists, pp. 500—501.
- ACGIH (1980) *Threshold limit values for chemical substances and physical agents in the workroom environment with intended changes for 1980*, Cincinnati, OH, American Conference of Governmental Industrial Hygienists, p. 81.
- ADDINGTON, C., FISHER, F., NEUBAUER, R., OSBORNE, C., SARKEES, Y., & SWARTZ, G. (1958) Thermal effects of 200 megacycles (cw) irradiation as related to shape location and orientation in the field. In: *Proceedings of the 2nd Tri-Service Conference on the Biological Effects of Microwave Energy*, Charlottesville (ASTIA Document No. AD 131477).
- ADEY, W. R. (1975) Introduction: Effects of electromagnetic radiation on the nervous system. *Ann. N.Y. Acad. Sci.*, **247**: 15—20.
- ALBERT, E. N. & De SANTIS, M. (1975) Histological observations on the nervous system. In: Johnson, C. & Shore, M., ed. *Biological Effects of Electromagnetic Waves*, Washington, US Dept of Health, Education, and Welfare, pp. 299—310 (HEW Publication (FDA) 77-8010).
- ALBERT, E. N. (1979) Evidence of neuropathology in chronically irradiated hamsters by 2450 MHz microwaves at 10 mW/cm<sup>2</sup>. In: *USNC/URSI National Radio Science Meeting Bioelectromagnetics Symposium, Seattle, Washington, 18—22 June, 1979*, p. 335.
- ANSI (1966) *Safety level of electromagnetic radiation with respect to personnel*, New York, pp. 3—9 (USAS C. 95.1—1966).
- ANSI (1973) *Techniques and instrumentation for the measurement of potentially hazardous electromagnetic radiation at microwave frequencies*, New York, pp. 2—36 (ANSI C. 95.3—1973).
- ANSI (1974) *Safety level of electromagnetic radiation with respect to personnel*. New York, pp. 7—8 (ANSI C. 95.1—1974).
- ANSI (1979) *Draft: Safety level with respect to personnel of radiofrequency electromagnetic fields (300 kHz—300 GHz)*. New York.
- APPLETON, B. & McCROSSAN, G. C. (1972) Microwave lens effects in humans. *Arch. Ophthalmol.*, **88**: 259—262.
- APPLETON, B., HIRSCH, S., & KINION, R. O. (1975) Microwave lens effects in humans. *Arch. Ophthalmol.*, **93**: 257—258.
- ASLAN, E. (1972) Broadband isotropic electromagnetic radiation monitor. *IEEE Trans. Instrum. Mens.*, **1M-21**: 421—424.
- BAIRD, R. C. (1974) Methods of calibrating microwave hazard meters. In: Czernski, P., Ostrowski, K., Shore, M. L., Silverman, Ch., Suess, M. J., & Waldeskog, B., ed. *Biologic effects and health hazards of microwave radiation*, Warsaw, Polish Medical Publishers, pp. 228—236.
- BALDWIN, M., BACH, S. A., & LEWIS, S. A. (1960) Effects of radio-frequency energy on primate cerebral activity. *Neurology*, **10**: 178—187.
- BARANSKI, S. (1967) [*Investigations on biological specific effects of microwaves.*] Warsaw, Inspektorat lotnictwa, 162 pp. (in Polish).
- BARANSKI, S. (1971) Effects of chronic microwave irradiation on the blood-forming system of guinea pigs and rabbits. *Aerosp. Med.*, **42**: 1196—1199.
- BARANSKI, S. (1972) Effects of microwaves on the reactions of the white blood cell system. *Acta Physiol. Pol.*, **23**: 685—692.
- BARANSKI, S. & CZERSKI, P. (1976) *Biological effects of microwaves*. Stroudsburg, Dowden, Hutchinson & Ross, 234 pp.

- BARANSKI, S. & EDELWEJN, Z. (1968) Studies on the combined effect of microwaves and some drugs on bioelectric activity of the rabbits' CNS. *Acta Physiol. Pol.*, **19**: 31—41.
- BARANSKI, S. & EDELWEJN, Z. (1975) Experimental morphological and electroencephalographic studies of microwave effects on the nervous system. *Ann. N.Y. Acad. Sci.*, **247**: 109—116.
- BARANSKI, S., CZEKALINSKI, L., CZERSKI, P., & HADUCH, S. (1963) Recherches experimentales sur l'effet mortel de l'irradiation des ondes micrometriques. *Rev. Med. Aeronaut.*, **2**: 108—111.
- BARANSKI, S., EDELWEJN, Z., & KALETA, Z. (1967) Functional and morphologic examinations on the microwave irradiated muscles. *Acta Physiol. Polon.*, **19**: 37—46.
- BARANSKI, S., CZERSKI, P., & SZMIGIELSKI, S. (1969) Microwave effects on mitosis *in vivo* and *in vitro*. *Genet. Pol.*, **10** (3): 92—98.
- BARANSKI, S., CZERSKI, P., & SZMIGIELSKI, S. (1971) [The influence of microwaves on mitosis *in vivo* and *in vitro*.] *Postepy Fiz. Medycznej*, **6**: 93—108 (in Polish).
- BARANSKI, S., OSTROWSKI, K., & STODOLNIK-BARANSKA, W. (1973) Experimental investigations on the influence of microwaves on thyroid function. *Acta Physiol. Pol.*, **23**: 608—614.
- BARRON, C. I. & BARAFF, A. A. (1958) Medical considerations of exposure to microwaves (radar). *J.A.M.A.*, **168**: 1194—1199.
- BASSEN, H. J. & HERMAN, W. A. (1977) Precise calibration of planewave microwave power density using power equation techniques. *IEEE Trans. Microwave Theory Tech.*, **MTT-25** (8): 701—706
- BASSEN, H., HERCHENROEDER, P., CHEUNG, A., & NEUDER, S. (1977) Evaluation of an implantable electric-field probe within finite simulated tissues. *Radioscience*, **12**: 15—25.
- BASSEN, H. I., KANTOR, G., RUGGERA, P. S., & WITTERS, D. M. (1979) *Leakage in the proximity of microwave diathermy applicators used on humans or phantom models*, Rockville, US Dept of Health, Education, and Welfare, 9 pp. (HEW Publication (FDA) 79-8073).
- BAWIN, S. M. & ADEY, W. R. (1976) Sensitivity of calcium binding in cerebral tissue to weak environmental electric fields oscillating at low frequency. *Proc. Natl Acad. Sci.*, **73**: 1999—2003.
- BAWIN, S. M., GAVALAS-MEDICI, R. J., & ADEY, W. R. (1973) Effects of modulated very high frequency fields on specific brain rhythms in cats. *Brain Res.*, **58**: 365—385.
- BAWIN, S. M., KACZMAREK, L. K., & ADEY, W. R. (1975) Effects of modulated VHF fields on the central nervous system. *Ann. N.Y. Acad. Sci.*, **247**: 74—80.
- BEISCHER, D. E. & RENO, V. R. (1974) Microwave reflection and diffraction by man. In: Czerski, P., Ostrowski, K., Shore, M. L., Silverman, Ch., Suess, M. J., & Waldeskog, B., ed. *Biologic effects and health hazards of microwave radiation*, Warsaw, Polish Medical Publishers, pp. 254—259.
- BELOVA, S. F. (1960) The effects of microwave irradiation on the eye. In: *The effects of radar on the human body (results of Russian studies on the subject)*, Arlington, ASTIA, pp. 43—53. (ASTIA Dec. AD 278-172) (Translation from Gordon, Z. V. & Letavet, A. A., ed. *Biologiceskoe vozdeistvije sverchvysokich castot*. Moskva, Medičina, 1960).
- BEREZNICKAJA, A. N. (1968) [Some indices of fertility of female mice irradiated with 10 cm microwaves.] *Gig. Tr. Prof. Zabol.*, **9**: 33 (in Russian).
- BIGU-DEL-BLANCO, J., ROMERO-SIERRA, C., & WATTS, D. G. (1975) Microwave radiometry and its potential applications in biology and medicine: Experimental studies. *Biotelemetry*, **2**: 298—316.

- BIRENBAUM, L., KAPLAN, I. T., METLAY, W., ROSENTHAL, S. W., SCHMIDT, H., & ZARET, M. M. (1969) Effect of microwaves on the rabbit eye. *J. Microwave Power*, 4: 232—243.
- BLACKMAN, C. F., BENANE, S. G., WEIL, C. M., & ALI, J. S. (1975) Effects of non-ionizing electromagnetic radiation on single cell biologic systems. *Ann. N.Y. Acad. Sci.*, 247: 352—366.
- BLACKMAN, C. F., ELDER, T. A., WEIL, C. M., BENANE, S. G., EICHINGER, D. G., & HOUSE, D. E. (1979) Induction of calcium efflux from brain tissue by radio-frequency radiation: Effects of modulation frequency and field strength. *Radio Sci.*, 14 (6S): 93—98.
- BLISS, V. L. & HEPPNER, F. H. (1977) Effects of a field free space on the circadian activity rhythm of the house sparrow. In: Johnson, C. C. & Shore, M. L., ed. *Biological effects of electromagnetic waves. Symposium Proceedings, Boulder, October, 1975*, Rockville, US Dept of Health, Education, and Welfare, FDA, BRH, pp. 225—237 (HEW Publication (FDA) 77-8010).
- BOWMAN, R. R. (1970) Quantifying microwave hazardous fields, practical considerations. In: Cleary, S. F., ed. *Biological effects and health implications of microwave radiation. Symposium Proceedings, Richmond, 1969*. Rockville, Bureau of Radiological Health, Division of Biological Effects, pp. 204—209 (Report BRH-DBE 70—2).
- BOWMAN, R. R. (1974) Some recent developments in the characterization and measurement of hazardous electromagnetic fields. In: Czerski, P., Ostrowski, K., Shore, M. L., Silverman, Ch., Suess, M. J., & Waldeskog, B., ed. *Biologic effects and health hazards of microwave radiation*, Warsaw, Polish Medical Publishers, pp. 217—227.
- BOWMAN, R. R. (1976) A probe for measuring temperature in radio-frequency-heated material. *IEEE Trans. Microwave Theory Tech.*, 27: 43—45.
- BRAMALL, K. E. (1971) Accurate microwave high power measurements using a cascaded coupler method. *J. Res. Natl Bureau Stand.*, 75C: 185.
- BULGARIAN NATIONAL STANDARD (1979). *System of occupational safety standards. Radiofrequency electromagnetic fields. General requirements and safety*. Sofia, National Committee for Standardization.
- BYCHKOV, M. S. & DRONOV, I. S. (1974) *Electroencephalographic data on the effects of very weak microwaves at the level of the midbrain raticular formation-hypothalamus-cerebellar cortex level*, Springfield (Translation in NTIS Report No. JPRS 63321).
- BYCHKOV, M. S., MARKOV, V., & RYCHKOV, V. (1974) *Electroencephalographic changes under the influence of low intensity chronic microwave irradiation*, Springfield. (Translation in NTIS Report No. JPRS 63321).
- CAIRNIE, A. B. & HARDING, R. K. (1979) Further studies of testis cytology in mice irradiated with 2450-MHz microwaves. In: *USNC/URSI National Radio Science Meeting Bioelectromagnetic Symposium, Seattle, Washington, June 18—22*, p. 440.
- CANADIAN STANDARDS ASSOCIATION (1966) *Standard 265—1966 Radiation hazards from electronic equipment*. Ottawa, C.S.A.
- CARPENTER, R. L. (1969) Experimental microwave cataract: a review. In: Cleary, S. F., ed. *Biological effects and health implications of microwave radiation, Symposium Proceeding, Richmond, VA*, pp. 76—81.
- CARPENTER, R. L. & VAN UMMERSEN, C. A. (1968) The action of microwave radiation of the eye. *J. Microwave Power*, 3: 3—19.
- CARPENTER, R., FERRI, E. S., & HAGAN, G. J. (1974 a) Pitfalls in the assessment of microwave radiation as a hazard. In: *Proceedings of the 3rd International Congress of IRPA, Washington, DC, 1973*, pp. 76—78 (CONF/730907/PI USAEC 1974).
- CARPENTER, R. L., FERRI, E. S., & HAGAN, G. J. (1974 b) Assessing

- microwaves as a hazard to the eye — progress and problems. In: Czerski, P., Ostrowski, K., Shore, M. L., Silverman, Ch., Suess, M. J., & Waldeskog, B., ed. *Biologic effects and health hazards of microwave radiation*, Warsaw, Polish Medical Publishers, pp. 178—185.
- CETAS, T. C. (1975) A birefringent optical thermometer for measurements of electromagnetically induced heating. In: Johnson, C. C. & Shore, M. L. ed. *Biological effects of electromagnetic waves. Symposium Proceedings, Boulder, October 1975*, Rockville, US Dept of Health, Education, and Welfare, FDA, BRH, pp. 338—348 (Publication HEW-FDA 77.8011, Vol. II).
- CHEN, K. M., SAMUEL, A., & HOOPINGARNER, R. (1974) Chromosomal aberrations of living cells induced by microwave radiation. *Environ. Lett.*, **6**: 37—46.
- CHERNOVETZ, M. E., JUSTESEN, D. R., KING, N. W., & WAGNER, J. E. (1975) Teratology, survival and reversal of learning after fetal irradiation of mice by 2450 MHz microwave energy. *J. microwave Power*, **10**: 391.
- CHOU, C. K. & GUY, A. W. (1975) *The effects of electromagnetic fields on the nervous system*. Seattle, University of Washington, pp. 129 (Report No. 6) (Univ. Microfilm 76—17430).
- CHOU, C. K. & GUY, A. W. (1977) *Quantitation of microwave biological effects*. Rockville, pp. 81—103 (US DHEW Publication (FDA) 77—8026).
- CHOU, C. K., GUY, A. W., & GALAMBOS, R. (1977) Characteristics of cochlear microphonics. *Radio Sci.*, **12** (65): 221—227.
- CLEARY, S. F. (1973) Uncertainties in the evaluation of the biological effects of microwave and radiofrequency radiation. *Health Phys.*, **25**: 387—404.
- CLEARY, S. F. (1977) Biological effects of microwave and radiofrequency radiation. *CRC Crit. Rev. environ. Control*, **2**: 121—166.
- CLEARY, S. F. (1978) Survey of microwave and radiofrequency biological effects and mechanisms. In: Taylor, L. S. & Cheung, Y. A., ed. *Proceedings of a Workshop held at the University of Maryland, College Park, Maryland, 15—17 June*, US Dept of Health, Education, and Welfare, pp. 1—33 (HEW Publication (FDA) 78-8055).
- CLEARY, S. F. & PASTERNAK, B. S. (1966) Lenticular changes in microwave workers. *Arch. environ. Health*, **12**: 23—29.
- CLEARY, S. F. & WANGEMAN, R. W. (1976) Effect of microwave radiation on pentobarbital-induced sleeping time. In: Johnson, C. C. & Shore, M. L., ed. *Biological effects of electromagnetic waves. Symposium Proceedings, Boulder, October 1975*, Rockville, US Dept of Health, Education, and Welfare, FDA, BRH (Publication HEW-FDA 77.8011, Vol. I).
- CORELLI, J. C., GUTMAN, R. J., KOHAZI, S., & LEVY, J. (1977) Effects of 2.4—4.0 GHz microwave radiation of *E. coli* B. *J. microwave Power*, **12** (2): 141—144.
- CORNELIUS, W. A. & VIGLIONE, G. (1979) *Recommended permissible levels for exposure to microwave and radiofrequency radiation (10 MHz to 300 GHz). A proposal*. Victoria, Australian Radiation Laboratory, 16 pp. (ISSN 0157-1400).
- COUNCIL OF MINISTERS, Poland (1972) Decree concerning work safety and occupational hygiene during use of equipment generating electromagnetic fields in the microwave range. *Dziennik Ustaw PRL*, **21, II, 1972** (153) (in Polish).
- CRAWFORD, M. L. (1974) Generation of standard EM fields using TEM transmission cells. *IEEE Trans electromagn. Compat.*, **EMC-16**: 189—195.
- CZERSKI, P. (1975a) Experimental models for the evaluation of microwave biological effects. *Proc. IEEE*, **63**: 1540—1544.
- CZERSKI, P. (1975b) Microwave effects on the bloodforming system with particular reference to the lymphocyte. *Ann. N. Y. Acad. Sci.*, **247**: 232.
- CZERSKI, P. (1976) Comparison of the USA, USSR and Polish microwave permissible exposure standards. In: Carson, P. L. & Hendee, W. R., ed.

*Operational Health Physics. Proceedings of the 9th Midyear Symposium of the Health Physics Society, Denver, USA*, pp. 343—350.

- CZERSKI, P. & PIOTROWSKI, M. (1972) [Proposals for specification of allowable levels of microwave radiation.] *Med. Lotnicza*, **39**: 127—139 (in Polish). (Translation YPRS-59709 East European Scientific Affairs No. 343, 1973).
- CZERSKI, P. & SZMIGIELSKI, S. (1974) Microwave bioeffects. In: *Proceedings of the 5th European Microwave Conference, Hamburg, September 1974*, pp. 348—354.
- CZERSKI, P., OSTROWSKI, K., SHORE, M. L., SILVERMAN, Ch., SUESS, M. J., & WALDESKOG, B., ed. (1974a) *Biologic effects and health hazards of microwave Radiation*, Warsaw, Polish Medical Publishers, 350 pp.
- CZERSKI, P., PAPROCKA-SLONKA, E., SIEKIERZYNSKI, M., & STOLARSKA, A. (1974b) Influence of microwave radiation on the hematopoietic system. In: Czernski, P., Ostrowski, K., Shore, M. L., Silverman, Ch., Suess, M. J., & Waldeskog, B., ed. *Biologic effects and health hazards of microwave radiation*, Warsaw, Polish Medical Publishers, pp. 67—74.
- CZERSKI, P., PAPROCKA-SLONKA, E., & STOLARSKA, A. (1974c) Microwave irradiation and the circadian rhythm of bone marrow cell mitoses. *J. microwave Power*, **9**: 31—37.
- CZERSKI, P., SIEKIERZYNSKI, M., & GIDYNSKI, A. (1974d) Health surveillance of personnel occupationally exposed to microwaves. I. Theoretical considerations and practical aspects. *Aerosp. Med.*, **45**: 1137—1142.
- D'ANDREA, J. A., GANDHI, O. P., & LORDS, J. L. (1977) Behavioral and thermal effects of microwave radiation at resonant and nonresonant wavelengths. *Radio Sci.*, **12**: 251—256.
- DEFICIS, A. & PRIOU, A. (1976) Non-perturbing microprobes for measurement in electromagnetic fields. *J. microwave Power*, **11**: 148—149.
- DEICHMANN, W. B. (1966) Biological effects of microwave radiation of 24 000 Megacycles. *Arch. Toxicol.*, **22**: 24—35.
- DEICHMANN, W. B., BERNAL, E., & KEPLINGER, M. (1959) Effects of environmental temperature and air volume exchange on survival of rats exposed to microwave radiation of 24 000 Megacycles. *Ind. Med. Surg.*, **28**: 535—538.
- DEICHMANN, W. B., BERNAL, E., STEPHENS, E. H., & LANDEEN, K. (1963) Effect on dogs of chronic exposure to microwave radiation. *J. occup. Med.*, **5**: 418.
- DEICHMAN, N. B., MIALE, J., & LANDEEN, K. (1964) Effect of microwave radiation on the hemopoietic system of the rat. *Toxicol. appl. Pharmacol.*, **6**: 71—77.
- DE LORGE, J. O. (1976) The effects of microwave radiation on behavior and temperature in rhesus monkeys. In: Johnson, C. C. & Shore, M. L., ed. *Biological Effects of Electromagnetic Waves, Symposium Proceedings, Boulder, October 1975*, Rockville, US Dept Health, Education, and Welfare, FDA, BRH p. 141 (Publication HEW-FDA 77.8010, Vol. I).
- DE LORGE, J. (1979) Operant behaviour and rectal temperature of squirrel monkeys during 2.45 GHz microwave irradiation. *Radio Sci.*, **14** (6S): 217—225.
- DEROCHE, M. (1971) Etude des perturbations biologiques chez les techniciens O.R.T.F. dans certains champs électromagnétiques de haute fréquence. *Arch. Mal. prof.*, **32**: 679—683.
- DIETZEL, F. (1975) Effects of non-ionizing electromagnetic radiation on the development and intrauterine implantation of the rat. *Ann. N. Y. Acad. Sci.*, **247**: 367—376.
- DJORDJEVIC, Z., LAZAREVIC, N., & DJOKVIC, V. (1977) Studies on the hematologic effects of long-term, low-dose microwave exposure. *Aviation, space environ. Med.*, **48**: 516—518.



- DODGE, C. H. & GLASER, R., Jr. (1977) Trends in electromagnetic radiation bioeffects research and related occupational safety aspects. *J. microwave Power*, **12**: 319—334.
- DUMANSKII, Ju. D. & ŠANDALA, M. G. (1974) The biologic action and hygienic significance of electromagnetic fields of superhigh and ultrahigh frequencies in densely populated areas. In: Czernski, P., Ostrowski, K., Shore, M. L., Silverman, Ch., Suess, M. J., & Waldeskog, B., ed. *Biologic effects and health hazards of microwave radiation*, Warsaw, Polish Medical Publisher, pp. 289—293.
- DUMANSKII, Ju. D., SERDJUK, A. M., & LOS, T. P. (1975) [*Influence of radiofrequency electromagnetic fields on man.*] Kiev, Zdorovja, 215 pp. (in Russian).
- DURNEY, C. H., JOHNSON, C. C., BARBER, P. W., MASSOUDI, H., ISKANDER, M. F., LORDS, J. L., RYSER, D. K., ALLEN, S. J., & MITCHELL, J. C. (1978) *Radiofrequency dosimetry handbook*, (2nd ed.), Texas, Brooks Air Force Base, 141 pp. (Report No. SAM-TR-78-22).
- DURNEY, C. H., ISKANDER, M. F., MASSOUDI, H., ALLEN, S. J., & MITCHELL, J. C. (1980) *Radiofrequency radiation dosimetry handbook*. (3rd ed.), Texas, Brooks Air Force Base, 136 pp. (Report SAM-TR-80-32).
- EDELWEJN, Z. & BARANSKI, S. (1966) [Investigation of the effects of irradiation on the nervous system of personnel working with microwave fields.] *Lek. Wojsk.*, **9**: 781—786 (in Polish).
- EGGERT, S. & GOLTZ, S. (1976) [NFM-1 — an aperiodic near-field intensity measuring instrument for measurements at highfrequency workplaces.] *Radio Ferns. Elekt.*, **25**: 488—490 (in German).
- EGGERT, S., GOLTZ, S., & KUPPER, J. (1979) Near-zone field-strength meter for measurement of RF electric fields. *Radio Sci.*, **14** (6S): 9—14.
- ELDER, J. A. & ALI, J. S. (1975) The effect of microwaves (2450 MHz) on isolated rat liver mitochondria. *Ann. N. Y. Acad. Sci.*, **247**: 251—262.
- ELY, T. S. & GOLDMAN, D. E. (1956) Heat exchange characteristics of animals exposed to 10 centimeter microwave. *IRE Trans. med. Electron.*, **PGME 4**: 38—49.
- ELY, T. S., GOLDMAN, D. E., HEARON, Y. S., WILLIAMS, R. B., & CARPENTER, H. M. (1954) *Heating characteristics of laboratory animals exposed to ten centimeter microwaves*. Bethesda, MD, Naval Medical Research Inst. (Report NM 001.256).
- ELY, T. S., GOLDMAN, D. E., & HEARON, J. Z. (1964) Heating characteristics of laboratory animals exposed to ten centimeter microwaves. *IEEE Trans. biomed. Eng.*, **BE-11**: 123.
- ENGEN, C. F. (1971) An improved method for microwave power calibration with application of the valuation of connectors. *J. Res. Natl. Bur. Stand.*, **75** (C): 89—98.
- ENGEN, G. F. (1973) *Theory of VHF and microwave measurements using the power equation concept*. Washington, DC, National Bureau of Standards. (NBS Tech. Note 637, April 1973).
- FERRI, E. S. & HAGAN, G. J. (1976) *Chronic low-level exposure of rabbits to microwaves*, Rockville, US Dept of Health, Education and Welfare, pp. 129—142 (US DHEW Publication (FDA) 70-8010).
- FOSTER, K. R. & FINCH, E. D. (1974) Microwave hearing: evidence for thermo-acoustic auditory stimulation by pulsed microwaves. *Science*, **185**: 256—258.
- FREY, A. H. (1961) Auditory system response to radiofrequency energy. *Aerosp. Med.*, **32**: 1140—1142.
- FREY, A. H. (1967) Brain stem evoked responses associated with low intensity pulsed VHF energy. *J. appl. Physiol.*, **23**: 984—988.
- FREY, A. H. (1971) Biological function as influenced by low-power modulated energy. *IEEE Trans. microwave Theory Techn.*, **19**: 153—164.
- FREY, A. H. (1977) Behavioural effects of electromagnetic energy. In: *Sym-*

- posium on *Biological Effects and Measurements of Radiofrequency/Microwaves*, Rockville, US Dept of Health, Education, and Welfare, pp. 11—22 (US HEW Publication (FDA) 77-8026).
- FREY, A. H., FELDT, S. R., & FREY, B. (1975) Neural function and behavior: Defining the relationship. *Ann. N. Y. Acad. Sci.*, **247**: 433—439.
- FROHLICH, H. (1968) Long-range coherence and energy storage in biological systems. *Int. J. quantum Chem.*, **11**: 641—649.
- GALLOWAY, W. D. (1975) Microwave dose-response relationship on two behavioral tasks. *Ann. N. Y. Acad. Sci.*, **247**: 410—416.
- GANDHI, O. P., HUNT, E. L., & D'ANDREA, T. A. (1977) Deposition of electromagnetic energy in animals and in models of man with and without grounding and reflector effects. *Radio Sci.*, **12**: 39—47.
- GANDHI, O. P., SEDIGH, K., BECK, G. S., & HUNT, E. L. (1977) Distribution of electromagnetic energy deposition in models of man with frequencies near resonance. In: Johnson, C. C. & Shore, M. L., ed. *Biological Effects of Electromagnetic Waves, Symposium Proceedings, Boulder, October 1975*, Rockville, US Dept of Health, Education, and Welfare, FDA, BRH, pp. 44—67 (Publication (FDA) HEW 77-8011, Vol. II).
- GANDHI, O. P., HAGMAN, M. J., & D'ANDREA, J. A. (1979) Part-body and multibody effects on absorption of radiofrequency electromagnetic energy by animals and by models of man. *Radio Sci.*, **14** (6S): 15—21.
- GDR STANDARD TGL 32602/01 (1975) *Industrial hygiene: electric, magnetic and electromagnetic fields and waves; microwave and highfrequency range definitions, permissible power density, permissible field strength, measuring method.*
- GILLARD, J., SERVANTIE, B., BERTHARION, G., SERVANTIE, A. M., & OBRENOVITCH, J. K. C. (1976) Study of the microwave induced perturbations of the behavior by the open field test in the white rat. In: Johnson, C. C. & Shore, M. L., ed. *Biological effects of electromagnetic waves, Symposium Proceedings, Boulder, October 1975*, Rockville, US Dept of Health, Education, and Welfare, FDA, BRH, p. 693. (Publication HEW-FDA 77.8010 Vol. I).
- GLASER, Z. R. & BROWN, P. F. (1976) *Eighth supplement to bibliography of reported biological phenomena ("effects") and clinical manifestations attributed to microwave and radiofrequency radiation.* Bethesda, MD, Naval Medical Research and Development Command, 26 pp.
- GLASER, Z. R., BROWN, P. F., & BROWN, M. S. (1976) *Bibliography of reported biological phenomena ("effects") and clinical manifestations attributed to microwave and radiofrequency radiation.* Bethesda, MD, Naval Medical Research and Development Command, 185 pp. (a compilation and integration of report and seven supplements).
- GLASER, Z. R., BROWN, P. F., ALLAMONG, T. M., & NEWTON, R. C. (1977) *Ninth supplement to bibliography of microwave and radiofrequency biologic effects.* Cincinnati, OH, US Dept of Health, Education, and Welfare, PHS, CDS, National Institute for Occupational Safety and Health, 60 pp.
- GOLDSTEIN, L. & SISKO, Z. (1974) A quantitative electroencephalographic study of the acute effects of x-bank microwaves in rabbits. In: Czernski, P., Ostrowski, K., Shore, M. L., Silverman, Ch., Suess, M. J., & Waldeskog, B., ed. *Biologic effects and health hazards of microwave radiation*, Warsaw, Polish Medical Publishers, pp. 128—133.
- GORDON, Z. V. (1966) *[Problems of industrial hygiene and the biological effects of electromagnetic superhigh frequency fields.]* Moscow, Medicina (in Russian) (English translation in NASA Rep. TT-F-633, 1976).
- GORDON, Z. V. (1970) Occupational health aspects of radiofrequency electromagnetic radiation. In: *Ergonomics and physical environmental factors.* Geneva, International Labour Office, pp. 159—174 (Occupational Safety and Health Series No. 21).

- GORODECKIJ, A. A., ed. (1964) [Biological effects of ultrasound and ultra-high-frequency electromagnetic waves.] Kiev, Naukova dumka (in Russian).
- GRODSKY, I. T. (1975) Possible physical substrates for the interaction of electromagnetic fields with biologic membranes. *Ann. N. Y. Acad. Sci.*, **247**: 117—124.
- GRUNDLER, W. & KEILMAN, F. (1978) Nonthermal effects of millimeter microwaves on yeast growth. *Z. Naturforsch.*, **33c**: 15—22.
- GUY, A. W. (1971) Analyses of electromagnetic fields induced in biological tissues by thermographic studies on equivalent phantom models. *IEEE Trans. Microwave Theory Tech.*, **MTT-19**: 205—214.
- GUY, A. W. (1974) Quantitation of induced electromagnetic field patterns in tissue and associated biologic effects. In: Czernski, P., Ostrowski, K., Shore, M. L., Silverman, Ch., Suess, M. J., & Waldskog, B., ed. *Biologic effects and health hazards of microwave radiation*, Warsaw, Polish Medical Publishers, pp. 203—216.
- GUY, A. W., CHOU, C. K., LIN, J. C., & CHRISTENSEN, D. (1975a) Microwave-induced acoustic effects in mammalian auditory systems and physical materials. *Ann. N. Y. Acad. Sci.*, **247**: 194—218.
- GUY, A. W., LIN, J. C., KRAMER, P. O., & EMERY, A. F. (1975b) Effects of 2450 MHz radiation on the rabbit eye. *IEEE Trans. Microwave Theory Tech.*, **MTT-23**(6): 492—498.
- GUY, A. W., WEBB, M. D., & SORENSEN, C. C. (1976) Determination of power absorption in man exposed to high frequency electromagnetic fields by thermographic measurements on scale models. *IEEE Trans. Biomed. Eng.*, **BME-23**: 361—371.
- HAGAN, G. J. & CARPENTER, R. L. (1976) *Relative cataractogenic potencies of two microwave frequencies (2.45 and 10 GHz)*. Rockville, US Dept of Health, Education, and Welfare, pp. 143—155 (US DHEW Publication (FDA) 77-8010).
- HAIDT, S. J. & MCTIGHE, A. H. (1973) The effect of chronic, low-level microwave radiation on the testicles of mice. In: Maley, S. W., ed. *IEEE-G-MIT International Microwave Symposium, University of Colorado, June 4—6, 1973*, pp. 324—325.
- HANKIN, N. N. (1974) *An evaluation of selected satellite communication systems as sources of environmental microwave radiation*, Silver Spring, MD, US Environmental Protection Agency, 56 pp. (Report EPA-520/2-74-008).
- HANKIN, N. N., TELL, R. A., ATHEY, W., & JANES, D. E. (1976) High power radiofrequency and microwave radiation sources: A study of relative environmental significance. In: Carson, P. L., Hendee, W. R., & Hunt, D. C., ed. *Operational Health Physics Proceedings of the 9th Mid-year Topical Symposium of American Health Physics Association, Denver, Colorado*, pp. 347—355.
- HANSEN, R. C. (1976) Circular-aperture axial power density. *Microwave J.*, **19**(2): 50—59.
- HAZZARD, D. G., ed. (1977) *Symposium on the Biological Effects and Measurements of RF/Microwaves*, Rockville, US Dept of Health, Education, and Welfare, FDA, BRH, 387 pp. (Report HEW-FDA 77-8026).
- HELLER, J. H. (1971) Cellular effects of microwave radiation. In: Cleary, S. F., ed. *Biological effects and health implications of microwave radiation*, Rockville, US Dept of Health, Education, and Welfare, pp. 116—121 (Report No. BRH/DBE 2/70).
- HELLER, J. H. & TELXEIRA-PINTO, A. A. (1959) A new physical method of creating chromosomal aberrations. *Nature (Lond.)*, **183**: 905—906.
- HOWLAND, Y. W. & MICHAELSON, S. M. (1959) Studies on the biological effects of microwave irradiation of the dog and rabbit. In: *Proceedings of*

- third Tri-Service Conference on Biological Effects of Microwave Radiating Equipment AD 212110, pp. 191—238.
- HUANG, A. T., ENGLE, M. E., ELDER, J. A., KINN, J. B., & WARD, T. R. (1977) The effect of microwave radiation (2450 MHz) on the morphology and chromosomes of lymphocytes. *Radio Sci.*, **12**: 173—177.
- HUDSON, P. A. (1966) A high directivity broadband coaxial coupler. *IEEE Trans. microwave Theory Tech.*, **MTT-14**: 293.
- HUDSON, P. A. & SAULSBURY, L. F. (1971) An adjustable-slotlength UHF coaxial coupler with decade bandwidth. *IEEE Trans. microwave Theory Tech.*, **MTT-19**: 781.
- HUNT, E. L., KING, N. W., & PHILLIPS, R. D. (1975) Behavioral effects of pulsed microwave radiation. *Ann. N. Y. Acad. Sci.*, **247**: 440—453.
- ILLINGER, K. H. (1971) Molecular mechanism for microwave absorption in biological systems. In: Cleary, S. F., ed. *Biological Effects and Health Implications of Microwave Radiation*, Rockville, US Dept of Health, Education, and Welfare, pp. 112—115 (Report No. BRH-DBE-70/2).
- ILLINGER, K. H. (1974) Interaction between microwave and millimeter-wave electromagnetic fields and biological systems. Molecular mechanisms. In: Czerski, P., Ostrowski, K., Shore, M. L., Silverman, Ch., Suess, M. J., & Waldskog, B., ed. *Biologic effects and health hazards of microwave radiation*, Warsaw, Polish Medical Publishers, pp. 160—172.
- INSTITUTE OF MAKERS OF EXPLOSIVES (1971) *Safety guide for the prevention of radiofrequency radiation hazards in the use of electric blasting caps*, New York, 20 pp. (Safety Library Publication 20).
- IRPA (1977) *Overviews on nonionizing radiation*. Washington, US Department of Health, Education, and Welfare, Bureau of Radiological Health, 75 pp.
- IVA Committee (1976) *Biological effects of electromagnetic fields*, Stockholm, Royal Swedish Academy of Engineering Sciences, 16 pp. (ISBN 91.7082 123 2).
- JANES, D. E. (1979) Radiofrequency environments in the United States. In: *Digest 1979 IEEE International Communications Conference*, pp. 31.4.1—31.4.5.
- JANES, D. E., LEACH, W. M., MILLS, W. A., MOORE, R. T., & SHORE, M. L. (1969) Effects of 2450 MHz microwaves on protein synthesis and on chromosomes in Chinese hamsters. *Nonioniz. Radiat.*, **1**: 125—134.
- JANIAK, M. & SZMIGIELSKI, S. (1977) Injury of all membranes in normal and SV40-Virus transformation fibroblasts exposed *in vitro* to microwaves (2450 MHz) or water bath hyperthermia (43°C). In: *International Symposium on Biological Effects of Electromagnetic Waves*, Airlie, Virginia, USA, 1977.
- JOHNSON, C. C. & GUY, A. W. (1972) Nonionizing electromagnetic wave effects in biological materials and systems. *Proc. IEEE*, **60**: 692—718.
- JOHNSON, C. C. & SHORE, M. L., ed. (1977) *Biological effects of electromagnetic waves, Symposium Proceedings, Boulder, October 1975*, Rockville, US Dept of Health, Education, and Welfare, 693 pp. (FDA, BRH, Publication HEW-FDA 77.8010).
- JOHNSON, C. C. & SHORE, M. L., ed. (1977) *Biological effects of electromagnetic waves. Symposium Proceedings, Boulder, October 1975*, Rockville, US Dept Health, Education, and Welfare, 461 pp. (FDA, BRH, Publication HEW-FDA 77.8011, Vol. II).
- JOHNSON, C. C., DURNEY, C. H., BARBER, P. W., MASSOUDI, H., ALLEN, S. T., & MITCHELL, T. C. (1976) *Radiofrequency radiation dosimetry handbook*. (1st ed.), Salt Lake City, University of Utah, 125 pp. (Report SAM-TR-76-35).
- JOHNSON, R. B., MIZUMARI, S., MYERS, D. E., GUY, A. W., & LOVELY, R. H. (1977) Effects of pre- and post-natal exposures to 918 MHz microwave radiation on the development and behavior in rats. In: *International*

- Symposium on Biological Effects of Electromagnetic Waves, Airlie, Virginia, USA, 1977.*
- JUSTESEN, D. R. (1978) The central nervous system and behavior. In: *IEEE Reprint Volume on biological effects of microwave radiation.*
- JUSTESEN, D. R. (1979) Behavioral and physiological effects of microwave radiation. *Bull. N.Y. Acad. Med.*, **55** (11): 1058—1078.
- JUSTESEN, D. R. & GUY, A. W., ed. (1977) *Symposium Proceedings, Amherst, October 1976. Radio Sci.*, **12**(6S): 1—293.
- JUSTESEN, D. R. & KING, N. W. (1970) Behavioral effects of low-level microwave irradiation in the close space situation. In: Cleary, S. F., ed. *Biological effects and health implications of microwave radiation, Symposium Proceedings*, Washington, DC, US Government Printing Office, pp. 154—179.
- KACZMAREK, L. K. & ADEY, W. R. (1974) Weak electric gradients change ionic and transmitter fluxes in cortex, *Brain Res.*, **66**: 537—540.
- KEILMANN, F. (1977) Nonthermal microwave resonances in living cells. In: *Proceedings of the NATO Advanced Study Institute "Coherence in Spectroscopy and Modern Physics", Versilia, Stuttgart, Federal Republic of Germany*, 18 pp.
- KHOLODOV, Yu. A. (1966) *The effect of electromagnetic and magnetic fields on the central nervous system.* Washington, DC, 250 pp. (Translation NASA TIF-465).
- KING, N. W., JUSTESEN, D. R., & CLARKE, R. L. (1971) Behavioral sensitivity to microwave irradiation. *Science*, **172**: 398—401.
- KITSOVSKAJA, I. A. (1964) [The effect of centimetre waves of different intensities on the blood of haemopoietic organs of white rats.] *Gig. Truda Prof. Zabol.*, **8**(14) (in Russian).
- KOLMITKIN, O. V., KUZNETSOV, V. I., & AKOEV, I. E. (1979) Microwave effect on the parameters of the model synaptic membrane. In: *USNC/URSI National Symposium, Seattle, 18—22 June, 1979*, 334 pp.
- KRAMER, P. O., EMERY, A. F., GUY, A. W., & LIN, J. C. (1975) The ocular effects of microwaves on hypothermic rabbits: a study of microwave cataractogenic mechanisms. *Ann. N. Y. Acad. Sci.*, **47**: 155—165.
- KRAMER, P., HARRIS, C., GUY, A. W., & EMERY, A. (1976) *Mechanism of microwave cataractogenesis in rabbits*, Rockville, US Dept of Health, Education, and Welfare, pp. 49—60 (US DHEW Publication (FDA) 77-8010).
- KRAMER, P., HARRIS, C., EMERY, A. F., & GUY, A. W. (1978) Acute microwave irradiation and cataract formation in rabbits and monkeys. *J. microwave Power*, **13**: 239—249.
- KRITIKOS, H. N. & SCHWAN, H. P. (1976) Formation of hot spots in multi-layer spheres. *IEEE Trans. biomed. Eng.*, **BME-22**: 168—192.
- KRITIKOS, H. N. & SCHWAN, H. P. (1979) Potential temperature rise induced by electromagnetic field in brain tissues. *IEEE Trans. biomed. Eng.*, **BME 26**: 29—34.
- KRUPP, J. H. (1977) The relationship of thermal stress to immune-system response in mice exposed to 2.6 GHz radio-frequency radiation. In: *Proceedings of an International Symposium on the Biological Effects of Electromagnetic Waves, Airlie, Virginia, USA, 1977.*
- KRYLOV, V. A. & JUCENKOVA, T. B. (1979) [Protection from electromagnetic radiation.] In: *Sovetskoe Radio*, Moskwa, 216 pp. (in Russian).
- KULIKOVSKAJA, E. L. (1970) [Protection from the effect of radiowaves.] *Leningrad Medicina*: 147 pp. (in Russian).
- LEITES, F. & SKURICVINA, L. A. (1961) [The influence of microwaves on adrenal cortex function.] *Bjul. Eksp. Biol. Med.*, **52**: 47—56 (in Russian).
- LENKO, Y., DOLATOWSKI, A., GRUSZECKI, L., KLAJMAN, S., & JANUSZKIEWICZ, L. (1966) [The influence of 10 cm radiowaves on the 17 — ketosteroid and 17 hydroxyketosteroid levels in rabbit urine.] *Przeglad Lekarski*, **22**: 296—302 (in Polish).

- LIN, J. (1976) Interaction of two cross-polarized electromagnetic waves with mammalian cranial structures. *IEEE Trans. biomed. Eng.*, **BME-23**(5): 371.
- LIN, J. C., GUY, A. W., & CALDWELL, L. R. (1977) Thermographic and behavioral studies of rats in the near field of 918 MHz radiations. *IEEE Trans. microwave Theory Tech.*, **MTT-25**: 833—836.
- LIN, J. C., NELSON, J. C., & EKSTROM, M. E. (1979) Effects of repeated exposure to 148-MHz radiowaves on growth and hematology of mice. *Radio Sci.*, **14**(6S): 173—179.
- LIN, L. M. & CLEARY, S. F. (1977) Effects of microwave radiation on erythrocyte membranes. In: *International Symposium on Biological Effects of Electromagnetic Waves, Airlie, Virginia, USA, 1977*.
- LIVINGSTON, G. K., JOHNSON, C. C., & DETHLEFSEN, L. A. (1979) Comparative effects of water bath and microwave-induced hyperthermia on cell survival of Chinese hamster ovary (CHO) cells. *Radio Sci.*, **14**(6S): 117—123.
- LIVINGSTON, G. K., ROZZELL, T. C., JOHNSON, C. C., & DURNY, C. H. (1976) Performance of the LCOF probe in calorimetric and tissue monitoring applications. In: Johnson, C. C. & Shore, M. L., ed. *Biological effects of electromagnetic waves, Symposium Proceedings, Boulder, October 1975*, Rockville, US Dept of Health, Education, and Welfare, FDA, BRH, pp. 239—248 (Publication HEW-FDA 77.8011 Vol. II).
- LOBANOVA, E. A. (1974) The use of conditioned reflexes to study microwave effects on the central nervous system. In: Czerski, P., Ostrowski, K., Shore, M. L., Silverman, Ch., Suess, M. J., & Waldeskog, B., ed. *Biologic effects and health hazards of microwave radiation*, Warsaw, Polish Medical Publishers, pp. 109—118.
- LOTZ, W. G. & MICHAELSON, S. M. (1978) Temperature and corticosterone relationships in microwave exposed rats. *J. appl. Physiol.*, **44**(3): 438—445.
- MANIKOWSKA, E., LUCIANI, J. M., SERVANTIE, B., CZERSKI, P., OBRENOVITCH, J., & STAHL, A. (1979) Effects of 9.4 GHz microwave exposure on meiosis in mice. *Experientia (Basel)*, **35**: 388—390.
- MARHA, I., MUSIL, J., & TUHA, H. (1971) *Electromagnetic fields and the living environment*, San Francisco, San Francisco Press, 134 pp.
- MASSOUDI, H. (1977) Long wavelength electromagnetic power absorption in ellipsoidal models of man and animals. *IEEE Trans. microwave Theory Tech.*, **MTT-25**: 40—41.
- MCLEES, B. D. & FINCH, E. D. (1973) Analysis of reported physiologic effects of microwave radiation. *Adv. biol. med. Phys.*, **14**: 163—223.
- MCREE, D. E. & WACHTEL, H. (1977) Microwave effects on nerve vitality. In: *International Symposium on Biological Effects of Electromagnetic Waves, Airlie, Virginia, USA, 1977*.
- MERRIT, T. H. (1977) Studies of blood-brain permeability after microwave radiation. Abstract: *International Symposium on Biological Effects of Electromagnetic Waves, Airlie, Virginia, USA, 1977*.
- MERRITT, Y. H., HARTZELL, R. H., & FRAZER, J. W. (1976) The effects of 1.6 GHz radiation on neurotransmitters in discrete areas of the rat brain. In: Johnson, C. C. & Shore, M. L., ed. *Biological effects of electromagnetic waves, Symposium Proceedings, Boulder, October 1975*, Rockville, US Dept of Health, Education, and Welfare, FDA, BRH (Publication HEW-FDA 77.8010, Vol. I).
- MICHAELSON, S. M. (1971) The tri-service program — A tribute to George M. Knauf, USAF (MC). *IEEE Trans. microwave Theory Tech.*, **MTT-19**: pp. 131—146.
- MICHAELSON, S. M. (1973) Thermal effects of single and repeated exposures to microwaves — a review. In: Czerski, P., Ostrowski, K., Shore, M. L., Silverman, Ch., Suess, M. J., & Waldeskog, B., ed. *Biologic effects*

- and health hazards of microwave radiation, Warsaw, Polish Medical Publishers, p. 1.
- MICHAELSON, S. M. (1977) *Microwave and radiofrequency radiation*, ICP/CEP 803. Copenhagen, World Health Organization, Regional Office for Europe, 98 pp.
- MICHAELSON, S. M., THOMSON, K. A. E., TAMANI, M. Y. E., SETH, H. S., & HOWLAND, J. W. (1961) The hematologic response to microwave irradiation of animals. *Am. J. Physiol.*, **201**: 351—360.
- MICHAELSON, S. M., THOMPSON, R. A. E., TAMANI, M. Y. E., SETH, H. S., & HOWLAND, J. W. (1964) The hematologic effects of microwave exposure. *Aerospace Med.*, **35**: 824—829.
- MICHAELSON, S. M., HOWLAND, J. W., & DEICHMAN, W. B. (1971) Response of the dog to 24,000 and 1285 MHz microwave exposure. *Ind. Med.*, **40**: 18—23.
- MICHAELSON, S. M., HOUK, W. M., LEBDA, N. J. A., LU, S. T. & MAGIN, R. L. (1975) Biochemical and neuroendocrine aspects of exposure to microwaves. *Ann. N.Y. Acad. Sci.*, **247**: 21—45.
- MICHAELSON, S. M., GUILLET, R., & HEGGENESS, F. W. (1977a) The influence of microwaves on development of the rat. In: *International Symposium on the Biological Effects of Electromagnetic Waves*, Airlie, Virginia, USA.
- MICHAELSON, S. M., GUILLET, R., & LOTZ, W. G. (1977b) *Neuroendocrine responses in the rat and dog exposed to 2450 MHz (cw) microwaves*, Rockville, US Dept of Health, Education, and Welfare, pp. 263—279 (DHEW Publication 77-8026).
- MIKOLAJCZYK, H. (1970) [Mitoses of corneal epithelial cells in microwave irradiated animals.] *Med. Pr.*, **21**: 15—20 (in Polish).
- MIKOLAJCZYK, H. (1972) Hormonal responses and changes in endocrine glands induced by microwaves. *Medycyna. Lotnicza*, **39**: 39—45.
- MIKOLAJCZYK, H. (1974) Microwave irradiation and endocrine function. In: Czerski, P., Ostrowski, K., Shore, M. L., Silverman, Ch., Suess, M. J., & Waldeskog, B., ed. *Biologic effects and health hazards of microwave radiation*, Warsaw, Polish Medical Publishers, pp. 46—57.
- MIKOLAJCZYK, H. (1977) *Microwave induced shifts of gonadotrophic activity in anterior pituitary gland of rats*, Rockville, US Dept of Health, Education, and Welfare, pp. 377—383 (US DHEW Publication (FDA) 77-8010).
- MILROY, W. C. & MICHAELSON, S. M. (1972) Thyroid pathophysiology of microwave radiation. *Aerospace Med.*, **43**: 1126—1131.
- MININ, B. A. (1974) [*Microwaves and human safety.*] (in Russian) (English translation, 1975 Report IPRS-65506-1 and IPRS-65506-2, NTIS, Springfield, Vols. I and II).
- MINISTER OF HEALTH AND SOCIAL WELFARE, POLAND (1972) [Decree concerning the definition of electromagnetic fields in the microwave range and the determination of permissible occupancy time for work in the hazardous zone.] In: *Dziennik Urzędowy Ministerstwa Zdrowia i Opieki Społecznej*, **78**, 20.09, No. 17 (in Polish).
- MINISTERS OF LABOUR, WAGES AND SOCIAL AFFAIRS AND OF HEALTH AND SOCIAL WELFARE, POLAND (1977) [Decree concerning work safety and occupational hygiene during use of equipment generating electromagnetic fields in the range 0.1 MHz to 300 MHz.] In: *Dziennik Ustaw PRL*, **19.3.1977**, No. 8 (in Polish).
- MINISTRY OF HEALTH OF THE USSR (1970) [*Health standards and guidelines for work with generators of high, ultrahigh and superhigh frequencies.*] (Ministry of Health of the USSR 30.03, 1970, No. 848-70) (in Russian).
- MIRO, L., LONBIERE, R., & PFISTER, A. (1965) Recherches des lésions viscérales observées chez des souris et des rats exposés aux ondes ultra-

- courtes, étude particulière des effets de ces ondes sur la reproduction de ces animaux. *Rev. Med. aeronaut., Paris*, 4: 37.
- MOE, K. E., LOVELY, R. H., MYERS, D. E., & GUY, A. W. (1977) *Physiological and behavioral effects of chronic low-level microwave radiation in rats*, Rockville, US Dept of Health, Education, and Welfare, pp. 248—255 (US DHEW Publication (FDA) 77-8010).
- MONAHAN, J. C. & HO, H. S. (1977) Microwave induced avoidance behavior in the mouse. In: Johnson, C. C. & Shore, M. L., ed. *Biological effects of electromagnetic waves, Symposium Proceedings, Boulder, October 1975*, Rockville, US Dept of Health, Education, and Welfare, FDA, BRH (Publication HEW-FDA 77.8010, Vol. I).
- MOSCOVICI, B., LAVYEL, A., & BEN-ITZHAC, D. (1974) Exposure to electromagnetic radiation among workers. *Fam. Physician*, 3(3): 121.
- MUMFORD, W. W. (1949) A broad-band microwave source. *Bell System tech. J.*, 28: 608—612.
- MUMFORD, W. W. (1961) Some technical aspects of microwave radiation hazards. *Proc. Inst. Radio Eng.*, 49(2): 427—477.
- MURACA, G. J., FERRI, E. S., & BUCHTA, F. L. (1976) *A study of the effects of microwave irradiation on the rat testes*, Rockville, US Dept of Health, Education, and Welfare, pp. 484—494 (US DHEW Publication (FDA) 77-8010).
- NAS/NRC (1977) *Occupational exposure to microwave radiation (radar)*. Washington, DC, National Academy of Sciences/National Research Council, 79 pp. (Final Report under Contract FDA-223-76-6003).
- NATIONAL HEALTH AND WELFARE, CANADA (1977) *Health aspects of radiofrequency and microwave radiation exposure, Part 1*, Ottawa, 80 pp. (Document 77-EHD-13).
- NATIONAL HEALTH AND WELFARE, CANADA (1978) *Health aspects of radiofrequency and microwave radiation exposure, Part 2*, Ottawa, 107 pp. (Document 78-EHD-22).
- NATIONAL HEALTH AND WELFARE, CANADA (1979) *Recommended safety procedures for the installation and use of radiofrequency and microwave devices in the frequency range 10 MHz—300 GHz. Health and Welfare Canada Safety Code — 6*, Ottawa (Publication 79-EHD-30, February 1979).
- NATIONAL HEALTH AND WELFARE, CANADA (1980) *Report on the survey of radiofrequency heaters*. Ottawa, 56 pp. (Document 80-EHD-47).
- NEUKSMAN, P. A. (1978) Biotelemetry antennas: The problem of small body-mounted antennas, Biosigma 78. In: *Proceedings of an International Conference in Paris, 1978*. pp. 2—8.
- NIKITINA, N. G., LOS, J. P., & MEDVEDEVA, L. H. (1976) [The influence of an electromagnetic field 5Hz from SHF-ovens on the living organism.] In: *Gigiena nasselennykh mest*, Kiev, Naučnaja Dumka, pp. 101—103 (in Russian).
- NIKOGOSJAN, S. W. (1962) [The influence of centimetre and decimetre waves on blood serum protein content and fractions in animals.] Abstract In: *Science Conferene of Military Medical Academy*, Leningrad, 33 pp. (in Russian).
- NIOSH (1973) *The industrial environment — its evaluation and control*, Rockville (US Dept of Health, Education, and Welfare Publication).
- OFFICE OF TELECOMMUNICATIONS POLICY (1974) *Report on Program for control of electromagnetic pollution of the environment: The assessment of biological hazards of electromagnetic radiation*, Washington, DC, Executive Office of the President, 57 pp.
- OSCAR, K. Y. & HAWKINS, T. D. (1977) Microwave alteration of the blood-brain barrier system of rats. *Brain Res.*, 126: 281—293.
- OSEPCHUK, J. M., FOERSTREN, R. A., & McCONNEL, D. R. (1973) Computation of personnel exposure in microwave leakage field and com-



- parison with personnel exposure in standards. In: *Proceedings of the 8th Annual Microwave Power Symposium, Loughborough, England, 10—13 September, 1973.*
- OSEPECHUK, J. M. (1979) Sources and basic characteristics of microwave radiation. *Bull. N.Y. Acad. Med.*, **55** (11): 976—998.
- PALMISANO, W. A. & PECZENIK, A. (1966) Some considerations of microwave hazard exposure criteria. *Mil. Med.*, **131**: 611.
- PARKER, L. N. (1973) Thyroid suppression and adrenomedullary activation by low-intensity microwave radiation. *Am. J. Physiol.*, **224**: 1388—1390.
- PAULSSON, L. E. (1976) Measurements of 0.915, 2.45 and 9.0 GHz absorption in the human eye. In: *Proceedings on the 6th European Microwave Conference, Rome, 14—17 September, Sevenoaks, England, Microwave Exhibitions and Publishers Ltd.*, pp. 117—121.
- PAULSSON, L. E., HAMNERIUS, Y., & McLEAN, W. G. (1977) The effects of microwave radiation on microtubules and axonal transport. *Radiat. Res.*, **70**: 212—223.
- PAULSSON, L. E., HAMNERIUS, Y., HANSSON, H. A., & SJÖSTRAND, J. (1979) Retinal damage experimentally induced by microwave radiation at 55 mW/cm<sup>2</sup>. *Acta Ophthalmol.*, **57**: 183—197.
- PEAK, D. W., CONOVER, D. L., HERMAN, W. A., & SHUPING, R. E. (1975) *Measurement of power density from marine radar*. Rockville, US Dept of Health, Education, and Welfare, 18 pp. (DHEW Publication (FDA) 76—8004).
- PETROV, I. R., ed. (1970) [*Influence of microwave radiation on the organism of man and animals.*] Leningrad, Medicina, 212 pp. (in Russian) (English translation: Springfield, Report NTIS N 72-22073).
- PETROV, I. R. & SYNGAJEVSKAJA, V. A. (1970) [Endocrine glands.] In: Petrov, I. R., ed. *Influence of microwave radiation on the organism of man and animals.* Leningrad, Medicina, pp. 212. (English translation (1972) Springfield Report NTIS N 72-22073).
- PHILLIPS, R. D., KING, N. W., & HUNT, E. L. (1973) Thermoregulatory, cardiovascular and metabolic response of rats to single and repeated exposure to 2450 MHz microwaves. In: *Proceedings of the 8th Annual Microwave Power Symposium, Loughborough, England, 10—13 September, 1973.*
- PILLA, A. A. (1979) Low frequency electromagnetic induction of electrochemical information at living cell membranes: A new tool for the study and modulation of the kinetics of cell function. In: *USNC/URSI National Radio Science Meeting, Bioelectromagnetics Symposium, Seattle, Washington, 18—22 June, 1979*, p. 303.
- POVŽITKOV, V. A., TYAGIN, N. V., & GREBEŠČNIKOVA, A. M. (1961) [The influence of pulsed super-high frequency fields on contraception and the course of gestation in white mice.] *Bull. exper. Biol. med. Biol.*, **51**: 105 (in Russian).
- PORTELA, A., VACCARI, Y. G., MICHAELSON, S. M., LLOBERA, O., BRENNAN, M., GOSZTONYI, A. E., PEREZ, J. C., & JENERICK, H. (1975) Transient effects of low level microwave irradiation on muscle cell bioelectric properties, water permeability and water distribution. *Stud. Biophys.*, **53**: 197—224.
- PRAUSNITZ, S. & SUSSKIND, C. (1962) Effects of chronic microwave irradiation in mice. *IEEE Trans. Med. Electron.*, **BME-9**: 104—108.
- PRESMAN, A. S. (1968) *Electromagnetic fields and life*. New York, Plenum Press, 332 pp.
- PRINCIPAL HYGIENIST OF CSSR (1965) [Unified methods for measurements of field intensity and irradiation by electromagnetic waves in the range of high frequency and very high frequency for hygienic purposes; preventive medical examinations of persons exposed to such irradiation.] In: *Priloha e2 k Informacnim zpravam z oboru hygieny*

- prace a nemoci z povolání. Prague, Institute of Industrial Hygiene and Occupational Diseases, 10 pp. (in Czech).
- PRINCIPAL HYGIENIST OF CSSR (1970) [Unified methods for measurements of field intensity and irradiation by electromagnetic waves in the range of high frequency and very high frequency for hygienic purposes.] In: *Priloha c 3.k Informačním zprávám z oboru hygieny práce a nemoci z povolání*. Prague, Institute of Industrial Hygiene and Occupational Diseases, 13 pp. (in Czech).
- RABINOWITZ, J. R. (1973) Possible mechanism for biomolecular absorption of microwave radiation with functional implications. In: *International Microwave Symposium, 1973, Boulder, Abstracts*, 314 pp. (IEEE-G-MIT).
- REMARK, D. G. (1971) *Survey of diathermy equipment use in Pinellas County, Florida*. Rockville, US Dept of Health, Education, and Welfare, Food and Drug Administration, 38 pp. (Bureau of Radiological Health Report BRH/NERHL-71-1).
- REPACHOLI, M. H. (1978) Proposed exposure limits for microwave and radiofrequency radiation in Canada. *J. microwave Power*, **13**: 199—211.
- RICHARDSON, A. W., DUANE, T. D., & HINES, H. M. (1948) Experimental lenticular opacities produced by microwave irradiation. *Arch. phys. Med.*, **29**: 765—769.
- ROBERTI, B., HEEBELS, G. H., HENDRIX, J. C. M., DeGREEF, A. H. A. M., & WOLTHIUS, O. L. (1975) Preliminary investigations on the effects of low-level microwave radiation on spontaneous motor activity in rats. *Ann. N.Y. Acad. Sci.*, **247**: 417—424.
- ROBINETTE, C. D. & SILVERMAN, Ch. (1977) *Causes of death following occupational exposure to microwave radiation (radar) 1950—1974*, Rockville, US Dept of Health, Education, and Welfare, pp. 338—344 (US DHEW Publication (FDA) 77-8026).
- ROMERO-SIERRA, C., TANNER, J. A., & BIGU DEL BLANCO, J. (1974) Interaction of electromagnetic fields and living system. In: Czernski, P., Ostrowski, K., Shore, M. L., Silverman, Ch., Suess, M. J., & Waldskog, B., ed. *Biologic effects and health hazards of microwave radiation*, Warsaw, Polish Medical Publishers, pp. 145—151.
- ROSENTHAL, S. W., BIRENHAWN, L., KAPLAN, J. T., METLAY, W., SNYSLER, W. Z., & ZARET, M. M. (1976) *Effects of 35 and 107 GHz CW microwaves on the rabbit eye*. Rockville, US Dept of Health, Education, and Welfare, pp. 110—128 (US DHEW Publication (FDA) 77-8010).
- ROTKOVSKÁ, D. & VACEK, A. (1975) The effect of electromagnetic radiation on the hematopoietic stem cells of mice. *Ann. N.Y. Acad. Sci.*, **247**: 243—250.
- ROWE, W. D., JANES, D. E., & TELL, R. A. (1973) An assessment of adverse health effects of telecommunications technology. In: *Telecommunications Conference of Technology Forecasting and Assessment Session, Atlanta, GA*, pp. 1—7.
- RUDNEV, M. I., KAPUSTIN, A. A., LEONSKAJA, G. I., & KONOBEVA, G. I. (1976) [Cytological effects of electromagnetic energy in the super-high frequency range.] *Citol. i Genet.*, **10**: 400—402 (in Russian).
- RUGGERA, P. S. (1977) Near-field measurement of RF field. In: Hazzard, D. G., ed. *Symposium on the Biological Effects and Measurements of RF/Microwaves*, Rockville, US Dept of Health, Education, and Welfare, pp. 109—116 (Report HEW-FDA 77-8026).
- RUGGERA, P. S. (1979) *Measurements of electromagnetic fields in the close proximity of CB Antennas*, Rockville, US Dept of Health, Education, and Welfare, 23 pp. (US DHEW Publication (FDA) 79-8080).
- RUGGERA, P. S. & ELDER, R. L. (1971) *Electromagnetic radiation interference with cardiac pacemakers*, Rockville, US Dept of Health, Education, and Welfare, 19 pp. (US DHEW Publication No. BRH/DEP-71-5).

- SADČIKOVA, M. N. (1974) Clinical manifestations of reactions to microwave irradiation in various occupational groups. In: Czerski, P., Ostrowski, K., Shore, M. L., Silverman, Ch., Suess, M. J., & Waldeskog, B., ed. *Biologic effects and health hazards of microwave radiation*, Warsaw, Polish Medical Publishers, pp. 273—280.
- SCHOLL, D. M. & ALLEN, S. J. (1979) Skilled visual-motor performance by monkeys in a 1.2 GHz microwave field. *Radio Sci.*, **14**: (6S): 247—252.
- SCHWAN, H. P. (1971) Interaction of microwave and radiofrequency with biological systems. *IEEE Trans. microwave Theory Tech.*, **MTT-19**: 146—152.
- SCHWAN, H. P. (1976) Principles of interaction of microwave field at the cellular and molecular level. In: Johnson, C. C., Durney, C. H., & Barber, P. W., ed. *Radiofrequency radiation dosimetry handbook*, 1st ed., Salt Lake City, University of Utah (Report No. SAM-TR-76-35).
- SCHWAN, H. P. (1978) Classical theory of microwave interaction with biological systems. In: Taylor, L. S. & Cheung, Y., ed. *Proceedings of a Workshop on the Physical Basis of Electromagnetic Interactions with Biological Systems., held at the University of Maryland, College Park, MD, 15—17 June*, Rockville, US Dept of Health, Education, and Welfare, 400 pp. (US DHEW document No. HEW-FDA 78-8055).
- SCHWAN, H. P. & PIERSOL, G. M. (1954) Absorption of electromagnetic energy in body tissues. Part I. Biophysical consideration. *Am. J. Phys. Med.*, **33**: 371—404.
- SCHWAN, H. P. & PIERSOL, G. M. (1955) Absorption of electromagnetic energy in body tissues. Part II. Physiological aspects. *Am. J. Phys. Med.*, **34**: 425—448.
- SERDJUK, A. M. (1977) [*Interaction of the organism and environmental electromagnetic fields.*] Kiev, Naukova Dumka, 172 pp. (in Russian).
- SERVANTIE, B., BERTHARION, G., JOLY, R., SERVANTIE, A. M., ETIENNE, J., DREYFUS, P., & ESCOUBET, P. (1974) Pharmacologic effects of a pulsed microwave field. In: Czerski, P., Ostrowski, K., Shore, M. L., Silverman, Ch., Suess, M. J., & Waldeskog, B., ed. *Biologic effects and health hazards of microwave radiation*, Warsaw, Polish Medical Publishers, pp. 36—45.
- SERVANTIE, B., SERVANTIE, A. M., & ETIENNE, J. (1975) Synchronization of cortical neurons by a pulsed microwave field as evidenced by special analysis of electrocardiograms from the white rat. *Ann. N.Y. Acad. Sci.*, **244**: 82—86.
- SERVANTIE, B., OBRENOVITCH, J., & CRETON, B. (1978) *Pathologie humaine due au radar*. Abstr. URSI General Assembly, Helsinki.
- SHACKLETT, D. E., TREDICI, T. J., & EPSTEIN, D. L. (1975) Evaluation of possible microwave induced lens changes in the United States Air Force. *Aviat. space environ. Med.*, **Nov.**: 1403—1406.
- SHAPIRO, A. R., LUTOMIRSKI, R. F., & YURA, H. T. (1971) Induced fields and heating within the cranial structure irradiated by an electromagnetic plane wave. *IEEE Trans. microwave Theory Tech.*, **MTT-19**: 187—197.
- SHORE, M. L., FELTON, R. D., & LAMANNA, A. (1977) *The effect of repetitive prenatal low-level microwave exposure on development in the rat*, Rockville, US Dept of Health, Education, and Welfare, pp. 280—289 (US DHEW Publication (FDA) 77-8026).
- SIEKIERZYNSKI, M. (1973) A study of the health status of microwave workers. In: Czerski, P., Ostrowski, K., Shore, M. L., Silverman, Ch., Suess, M. J., & Waldeskog, B., ed. *Biologic effects and health hazards of microwave radiation*, Warsaw, Polish Medical Publishers.
- SIEKIERZYNSKI, M., CZERSKI, P., MILCZAREK, H., GIDYNSKI, A., CZARNECKI, C., DZIUK, E., & JEDRZEJCZAK, W. (1974a) Health sur-

- veillance of personnel occupationally exposed to microwave. II. Functional disturbances. *Aerosp. Med.*, **45**: 1143—1145.
- SIEKIERZYNSKI, M., CZERSKI, P., GIDYNSKI, A., ZYDECKI, S., CZARNECKI, C., DZIUK, E., & JEDRZEJCZAK, V. (1974b) Health surveillance of personnel occupationally exposed to microwave. III. Lens translucency. *Aerosp. Med.*, **45**: 1146—1148.
- SILVERMAN, C. (1973) Nervous and behavioral effects of microwave radiation in human. *J. Epidemiol.*, **97**: 219—224.
- SMIALOWICZ, R. J. (1977) *The effects of microwaves (2450 MHz) on lymphocyte blast transformation in vitro*, US Dept of Health, Education, and Welfare, Rockville, pp. 472—483 (US DHEW Publication (FDA) 77-8010).
- SMIALOWICZ, R. J., KINN, J. B., WEIL, C. C. M., & WARD, T. R. (1977) Chronic exposure of rats to 425- or 2450-MHz microwave radiation: effects on lymphocytes. In: *International Symposium on the Biological Effects of Electromagnetic Waves, Airlie, Virginia, USA, 1977*.
- SMITH, W. S. & BROWN, D. G. (1971) *Radiofrequency and microwave radiation levels resulting from man-made sources in the Washington, DC area*, Rockville, US Dept of Health, Education, and Welfare, 56 pp. (US DHEW Publication (FDA) 72—8015, BRH/DEP 72-5).
- STEWART-DEHAAN, P. J., CREIGHTON, M. O., ROSS, W. M., & TEVITHICK, Y. R. (1979) Heat-induced cataracts in the rat lens *in vitro*. In: *USNC/URSI National Symposium, Seattle, 18—22 June, 1979*, 447 pp.
- STODOLNIK-BARANSKA, W. (1967) Microwave induced lymphoblastoid transformation of human lymphocytes *in vitro*. *Nature (Lond.)*, **214**: 202.
- STODOLNIK-BARANSKA, W. (1974) The effects of microwaves on human lymphocyte cultures. In: Czerski, P., Ostrowski, K., Shore, M. L., Silverman, Ch., Suess, M. J., & Waldeskog, B., ed. *Biologic effects and health hazards of microwave radiation*. Warsaw, Polish Medical Publishers, pp. 189—195.
- STRAUB, D. (1978) Molecular absorption of non-ionizing radiation in biological systems. In: Taylor, L. S. & Cheung, Y., ed. *Proceedings of a Workshop on the Physical Basis of Electromagnetic Interactions with Biological Systems, held at the University of Maryland, College Park, MD, 15—17 June*, Rockville, US Dept of Health, Education, and Welfare, pp. 35—42 (US DHEW document No. HEW-FDA 78-8055).
- STUCHLEY, M. A. (1977) Potentially hazardous microwave sources — A review. *J. microwave Power*, **12**: 369—381.
- STUCHLEY, M. A. (1979) Interaction of radiofrequency and microwave radiation with living systems: A review of mechanisms. *Rad. environ. Biophys.*, **16**: 1—14.
- STUCHLEY, M. A., REPACHOLI, M. H., LECOYER, D., & MANN, R. (1980) Radiation survey of dielectric (RF) heaters in Canada, *J. microwave Power*, **15** (2): 113—121.
- STVERAK, I., MARHA, K., & PAFKOVA, G. (1974) Some effects of various pulsed fields on animals with audiogenic epilepsy. In: Czerski, P., Ostrowski, K., Shore, M. L., Silverman, Ch., Suess, M. J., & Waldeskog, B., ed. *Biological effects of microwave radiation*, Warsaw, Polish Medical Publishers, p. 141—144.
- SUBBOTA, A. G. (1972) Functional disturbances in various systems of the organism. In: Petrov, I. R., ed. *Influence of microwave radiation on the organism of man and animals*. Leningrad, Medicina, 70 pp. (in Russian) (English translation (1972) NTIS N 72-22073, Springfield).
- SUTTON, C. H. & CARROLL, F. B. (1979) Effects of microwave-induced hyperthermia on the blood-brain barrier of the rat. *Radio Sci.*, **14** (6S): 329—334.
- SVETLOVA, Z. P. (1962) [On changes in symmetrical unconditioned and conditioned reflexes in dogs exposed to decimeter SHF fields.] In: *Voprosy*

- biologičeskogo deistvija sverchwysoko — častnotnogo (SVTč) elektromagnitnogo polja. Leningrad, Noučnoi Konferencu, p. 43 (in Russian).
- SWICORD, M. L. & CHEUNG, A. Y. (1977) Mutual coupling between linear antennas. In: Johnson, C. C. & Shore, M. L., ed. *Symposium Proceedings on the Biological Effects of Electromagnetic Waves*, Rockville, US Dept of Health, Education, and Welfare, FDA, BRH, pp. 435—450 (HEW Publication (FDA) 77-8011, Vol. II).
- SWICORD, M. L., SAFFER, J., & CHEUNG, A. Y. (1977) A two impedance method for range dielectrometry. In: Johnson, C. C. & Shore, M. K., ed. *Symposium Proceedings on the Biological Effects of Electromagnetic Waves*, Rockville, US Dept of Health, Education, and Welfare, FDA, BRH, pp. 451—454 (HEW Publication (FDA) 77-8011, Vol. II).
- SYNAGAJEVSKAJA, V. A., IGNATIEVA, O. S., & PLISKINA, T. P. (1962) [The influence of superhigh frequency irradiation in the decimetre and metre range on the endocrine regulation of carbohydrate metabolism and the functional state of adrenals in rabbits and dogs.] Leningrad, Military Medical Academy, p. 22 (in Russian).
- TAYLOR, E. M. & ASHLEMAN, B. T. (1975) Some effects of electromagnetic radiation on the brain and spinal cord of cats. *Ann. N.Y. Acad. Sci.*, **241**: 63—73.
- TAYLOR, L. S. & CHEUNG, Y., ed. (1978) The physical basis of electromagnetic interactions with biological systems. In: *Proceedings of a Workshop held at the University of Maryland, College Park, Maryland, 15—17 June*, Rockville, US Dept of Health, Education, and Welfare, 400 pp. (HEW Publication (FDA) 78-8055).
- TELL, R. A. (1972) Broadcast radiation: how safe is safe? *IEEE Spectrum*, **9** (8): 43—51.
- TELL, R. A. & JANES, D. E. (1977) Broadcast radiation: A second look. In: Johnson, C. C. & Shore, M. L., ed. *Symposium Proceedings on the Biological Effects of Electromagnetic Waves*, Rockville, US Dept of Health, Education, and Welfare, FDA, BRH, p. 461 (HEW Report (FDA) 77-8011, Vol. II).
- TELL, R. A. & MANTIPLY, E. D. (1978) *Population exposure to VHF and UHF broadcast radiation in the United States*, Las Vegas, NV (USEPA Report No. ORP/EAD 78-5).
- TELL, R. A. & NELSON, J. C. (1974a) Microwave hazard measurements near various aircraft radars. *Rad. Data Rep.*, **15**: 161—179.
- TELL, R. A. & NELSON, T. C. (1974b) *RF pulse spectral measurements in the vicinity of several air traffic control radars*. Silver Spring, MD, 45 pp. (USEPA document No. EPA-520/1-74-005).
- TELL, R. A., NELSON, T. C., & HANKIN, N. N. (1974) HF spectral activity in the Washington, DC Area. *Rad. Data Rep.*, **15**: 549—558.
- TENGROTH, B. & AURELL, E. (1974) Retinal changes in microwave workers. In: Czerski, P., Ostrowski, K., Shore, M. L., Silverman, C., Suess, M. J., Waldeskog, B., ed. *Biologic effects and health hazards of microwave radiation*, Warsaw, Polish Medical Publishers, pp. 302—305.
- THOMAS, J. R., FINCH, E. D., FULK, D. W., & BURCH, L. S. (1975) Effects of low level microwave radiation on behavioral baselines. *Ann. N.Y. Acad. Sci.*, **247**: 425—432.
- TINNEY, C. E., LORDS, Y. L., & DURNEY, C. H. (1976) Rate effects in isolated turtle hearts induced by microwave irradiation. *IEEE Trans. Microwave Theory Tech.*, **MTT-24**: 18—24.
- TJAGIN, N. W. (1971) [Clinical aspects of superhigh frequency irradiation.] Leningrad, Medicina, 174 pp. (in Russian).
- TOLGSKAYA, M. S. & GORDON, Z. V. (1973) *Pathological effects of radio waves*, New York. B. Haigh Trans. Consultants Bureau.
- TOLGSKAJA, M. S., GORDON, Z. V., & LABANOVA, E. A. (1962) Morphologic changes in experimental animals exposed to pulsed and con-

- tinuous SHF. In: *The biological action of ultrahigh frequencies*, Washington, DC, Office of Technical Services, US Dept of Commerce (Joint Publications Research Service Dept. JPRS-12471).
- TYAZHELOV, V. V., TIGRANIAN, R. E., & KHIZHNIK, E. P. (1977) New artifact-free electrodes for recording of biological potentials in strong electromagnetic fields. *Radio Sci.*, **12** (65): 121—123.
- TYLER, P., ed. (1974) *Biologic effects of nonionizing radiation. Symposium Proceedings*, New York. *Ann. N.Y. Acad. Sci.*, **247**: 1—545.
- US CODE OF FEDERAL REGULATIONS (1970) USA performance standard for microwave ovens. Title 42. Pt. 78 Subpt. C., Sec. 78.212. *Fed. Reg.*, **35** (194): 15642.
- US DEPARTMENT OF COMMERCE (1976) *Non-ionizing radiation protection training manual for radiation control*, Atlanta, GA, Inst. of Technology, 951 pp. (NTIS Pub. PB-264-888 Part I and II).
- US ENVIRONMENTAL PROTECTION AGENCY (1973) *Environmental exposure to non-ionizing radiation*, Washington, DC, USEPA (Report EPA/ORP-38-2).
- USSR ACADEMY OF SCIENCES (1973) Scientific session on the division of general physics and astronomy, 17—18 January, 1973. *Usp. Fiz. Nauk*, **110**: 452—469 (July 1973) and *Sov. Phys. Usp.* **16** (4): 568—579 (January-February 1974).
- USSR Standard for Occupational Exposure GOST 12.1.006-76 (1976) [*Occupational safety standards system, electromagnetic fields of radio-frequency, general safety requirements. State standard of the USSR.*] Moskva, Izdaletstvo Slandartov p. 5 (in Russian).
- USSR Standard for Public Exposure SN-1823-78 (1978).
- VAN UMMERSEN, C. V. (1961) The effects of 2450 Mc radiation on the development of chick embryos. In: Peyton, K. F., ed. *Proceedings of the 4th Annual Tri-service Conference on Biological Effects of Microwave Radiating Equipment*. New York, Plenum Publ., pp. 201—219.
- VARMA, M. M. & TRABOULAY, E. A. (1975) Biological effects of microwave radiation on the testes of mice. *Experientia (Basel)*, **31**: 301.
- VINOGRADOV, G. T. & DUMANSKI, Ju. D. (1974) [Changes in antigenic properties of tissues: autoimmune phenomena induced by super-high frequency energy.] *Bull. Eksper. Biol.*, **8**: 76—79 (in Russian).
- WACHTEL, H., SEAMAN, R., & JOINES, W. (1975) Effects of low intensity microwaves on isolated neurons. *Ann. N.Y. Acad. Sci.*, **247**: 46—62.
- WANGEMAN, R. F. & CLEARY, S. F. (1976) The *in vivo* effects of 2.45 GHz microwave radiation of rabbit serum components and sleeping times. *Radiat. Environ. Biophysics*, **13**: 89—103.
- WEBB, S. J. & DODDS, D. D. (1968) Inhibition of bacterial cell growth by 136 GHz microwaves. *Nature (Lond.)*, **218**: 374—375.
- WEISS, M. M. & MUMFORD, W. W. (1961) Microwave radiation hazards. *Health Phys.*, **5**: 160—168.
- WEITER, J. J., FINCH, E. D., SCHULTZ, W., & FRATTALI, V. (1975) Ascorbic acid charged in cultured rabbit lenses after microwave irradiation. *Ann. N.Y. Acad. Sci.*, **47**: 175—181.
- WHO (1981) *Nonionizing radiation protection*. Copenhagen, World Health Organization Regional Office for Europe (WHO Regional Publications European Series No. 10).
- WIKTOR-JEDRZEJCZAK, W., AHMED, A., SELL, K. W., CZERSKI, P., & LEACH, W. M. (1977) Microwaves induce an increase in the frequency of complement receptor-bearing lymphoid spleen cells in mice. *J. Immunol.*, **118**: 1499—1502.
- WILLIAMS, R. J. & FINCH, E. D. (1974) Examination of the cornea following exposure to microwave radiation. *Aerospace Med.*, **45**: 393—396.
- WITTERS, D. M. & KANTOR, G. (1978) *Free space electric field mapping*

- of microwave applicators, Rockville, US Dept of Health, Education, and Welfare, 18 pp. (HEW Publication (FDA) 79-8074).
- WOODS, D. (1969) Standard intensity electromagnetics field installation for calibration of radiation hazard monitors from 400 MHz to 40 GHz. *Non-ioniz. Radiat.*, **9** (June).
- WORKER PROTECTION AUTHORITY (1976) *Swedish Non-ionizing Radiation Standards*. Stockholm, Worker Protection Authority.
- YAO, K. T. S. (1971) Haploid cells in rat kangaroo corneal endothelium cultures and x-ray induced chromosome aberrations. *Genetics*, **67**: 399—409.
- YAO, K. T. S., JILES, M. M. (1970) Effects of 2450 MHz microwave radiation on cultivated rat kangaroo cells. In: Cleary, S. F., ed. *Biological effects and health implications of microwave radiation*, Rockville, US Dept of Health, Education, and Welfare, pp. 123—133.
- ZARET, M. M. (1974) Selected cases of microwave cataract in man associated with concomitant annotated pathologies. In: Czerski, P., Ostrowski, K., Shore, M. L., Silverman, Ch., Suess, M. J., & Waldeskog, B., ed. *Biologic effects and health hazards of microwave radiation*, Warsaw, Polish Medical Publishers, pp. 294—301.
- ZYDECKI, S. (1974) Assessment of lens translucency in juveniles, microwave workers and in age-matched groups. In: Czerski, P., Ostrowski, K., Shore, M. L., Silverman, Ch., Suess, M. J., & Waldeskog, B., ed. *Biologic effects and health hazards of microwave radiation*, Warsaw, Polish Medical Publishers, pp. 306—308.

## GLOSSARY

---

Wherever possible, this glossary gives terms and definitions standardized by the International Electrotechnical Commission in the International Electrotechnical Vocabulary (IEV) or by the International Organization for Standardization (ISO). In such cases, the IEV number, or the number of the ISO standard in which the definition appears, is given in parentheses. The great majority of the terms and definitions are those of the IEV, and the help of Mr C. J. Stanford, General Secretary, International Electrotechnical Commission, in compiling the necessary information is gratefully acknowledged.

An annex at the end of the glossary includes a number of additional terms that have not been standardized.

**absorption** In radio wave propagation, attenuation of a radio wave due to its energy being dissipated, i.e., converted into another form such as heat (IEV 60-20-105).

**absorption cross-section; effective area** Of an [antenna], oriented for maximum power absorption unless otherwise stated, an area determined by dividing the maximum power absorbed from a plane wave by the incident power flux density, the load being matched to the [antenna] (IEV 60-32-035).

**admittance** The current flowing in a circuit divided by the terminal voltage; the reciprocal of the impedance (IEV 05-40-035).

**antenna** That part of a radio system which is designed to radiate electromagnetic waves into free space [or to receive them]. This does not include the transmission lines or waveguide to the radiator (IEV 60-30-005).

**antenna directivity** See **directivity**

**antenna gain** See **power gain of an antenna**

**antenna, dipole** See **dipole**

**antenna, horn** See **horn**

**antenna, isotropic** See **isotropic radiator**

**antenna pattern** See **radiation pattern**

**antenna scanning** See **scanning**

**attenuation** The progressive diminution in space of certain quantities characteristic of a propagation phenomenon (IEV 05-03-115).

**attenuation coefficient** The real part of the propagation coefficient. Synonym: **attenuation constant** (deprecated) (IEV 55-05-255).

**bel; decibel** Transmission units giving the ratio of two powers. The number of bels is equal to the logarithm to the base ten of the power ratio. The decibel is equal to one-tenth of a bel (IEV 55-05-120).

**coaxial pair** Two conductors, one being a wire or tube coaxially surrounded by the other which is in the form of a tube (IEV 55-30-45). A cable consisting principally of one or more coaxial pairs is termed a **coaxial cable** (IEV 55-30-50).

**conductance** The reciprocal of resistance (IEV 05-20-170). Symbol: G. Unit: siemens (S).

**conductivity** The scalar or matrix quantity whose product by the electric field strength is the conduction current density (IEV 121-02-1). It is the reciprocal of resistivity.

**continuous wave** A wave whose successive oscillations are, under steady-state conditions, identical.

**cross section** A measure of the probability of a specified interaction between an incident radiation and a target particle or system of particles. It is the reaction rate per target particle for a specified



process divided by the flux density of the incident radiation (microscopic cross section) (IEV 26-05-605).

**current density** A vector of which the integral over a given surface is equal to the current flowing through the surface. The mean density in a linear conductor is equal to the current divided by the cross-sectional area of the conductor (IEV 05-20-045).

**cycle** The complete range of states or values through which a phenomenon or periodic function passes before repeating itself identically (IEV 05-02-050).

**decibel** See **bel**

**dielectric constant** See **permittivity**

**dielectric (material)** A material in which all of the energy required to establish an electric field in the material is recoverable when the field or impressed voltage is removed. A perfect dielectric has zero conductivity and all absorption phenomena are absent. A complete vacuum is the only known perfect dielectric.

**dielectric saturation** Response of a dielectric in the limit of high electric field strengths, leading to a decrease of the real part of the permittivity with increasing field strength.

**dipole** A centre-fed open [antenna] excited in such a way that the standing wave of current is symmetrical about the mid point of the [antenna] (IEV 60-34-005).

**directivity** That property of an [antenna] by virtue of which it radiates more strongly in some directions than in others (IEV 60-32-130).

**displacement** See **electric flux density**

**dissipation factor** The reciprocal of the *Q-factor* (IEV 55-05-285). See **Q factor**.

**duty factor** The ratio of (1) the sum of pulse durations to (2) a stated averaging time. For repetitive phenomena, the averaging time is the pulse repetition period (IEV 531-18-15).

**duty ratio** The ratio, for a given time interval, of the on-load duration to the total time (IEV 151-4-13).

**effective area** See **absorption cross-section**

**effective radiated power in a given direction** The power supplied to the [antenna] multiplied by the gain of the [antenna] in that direction relative to a half-wave dipole (IEV 60-32-095).

**electric charge; quantity of electricity** Integral of electric current over time (ISO 31/V). Symbol: *Q*. Unit: coulomb (C).

**electric field strength** A vector the value of which equals the force exerted on a quantity of electricity divided by this quantity and the direction of which is that of the force (IEV 05-15-45).

**electric flux** Across a surface element, the scalar product of the surface element and the electric flux density (ISO 31/V).

**electric flux density** A vector quantity whose divergence equals the electric volume charge density. *Note: In vacuo*, it is at all points equal to the product of the electric field strength and the electric constant (IEV 121-01-21). Symbol: *D*. Obsolete synonym: displacement.

**electric susceptibility** The scalar or matrix quantity whose product by the electric field strength is the electric polarization (IEV 121-02-09).

**electromagnetic energy** The energy stored in an electromagnetic field (IEV 121-01-39).

**electromagnetic wave** A wave characterized by variations of the electric and magnetic fields (IEV 121-01-38).

**electrostatic field** That portion of the total electromagnetic field produced by a current-carrying conductor or charge distribution, the energy of which returns to the conductor when the current ceases or the charge distribution goes to zero.

**energy density** See **radiant energy density**

**far zone** See **radiation zone**

**ferromagnetic material** A material in which the predominant magnetic phenomenon is ferromagnetism. *Note:* The atoms or ions have magnetic moments which, over certain regions (domains), are aligned approximately in the same direction even in the absence of an externally applied magnetic field. When such a field is applied, the resultant moments of the domains tend to align so that the material exhibits considerable permeability. The degree of alignment within a domain decreases with increasing temperature (IEV 901-01-29).

**ferromagnetism** A phenomenon by which the magnetic moments of neighbouring atoms are aligned approximately in the same direction due to mutual interaction (IEV 901-01-28).

**field** 1. *In a qualitative sense*, a region of space in which certain phenomena occur. 2. *In a quantitative sense*, a scalar or vector quantity the knowledge of which allows the effects of the field to be evaluated (IEV 05-01-040).

**field strength** In radio wave propagation, the magnitude of a component of specified polarization of the electric or magnetic field. The term normally refers to the root-mean-square value of the electric field (IEV 60-20-070).

**flux** See **electric flux, magnetic flux**

**flux density** See **electric flux density, magnetic flux density**

**Fraunhofer region** Of a transmitting [antenna] system, the region which is sufficiently remote from the [antenna] system for the wavelets arriving from the various parts of the system to be considered to follow parallel paths (IEV 60-32-60).

**free space** An ideal, perfectly homogeneous medium possessing a dielectric constant of unity and in which there is nothing to reflect, refract, or absorb energy. A perfect vacuum possesses these qualities.

**frequency** The reciprocal of **period**, q.v.

**Fresnel region** Of a transmitting [antenna] system, the region near the [antenna] system where the wavelets arriving from the various parts of the system cannot be considered to follow parallel paths (IEV 60-32-065).

**gain** The increase in power between two points 1 and 2 at which the power is respectively  $P_1$  and  $P_2$ , expressed by the ratio  $P_2/P_1$  in transmission units (IEV 55-05-185).

**H field** See table

**horn** An elementary [antenna] consisting of a waveguide in which one or more transverse dimensions increase towards the open end (IEV 60-36-055).

**impedance** The complex representation of potential difference divided by the complex representation of current (ISO 31/V).

**impedance characteristic** Of a uniform transmission line, the impedance with which one end of the line must be terminated in order that the impedance presented at the other end shall have the same value as the terminating impedance. *Note:* The term is occasionally applied to a symmetrical two-terminal-pair network to denote the common value assumed by the two image impedances and the two iterative impedances (IEV 55-20-155).

**impedance, wave (at a given frequency)** The ratio of the complex number (vector) representing the transverse electric field at a point, to that representing the transverse magnetic field at that point. The sign is so chosen that the real part is positive (IEV 62-05-095).

**induction field** That part of the field of an [antenna] which is associated with a pulsation of energy to and fro between the [antenna] and the medium. *Note:* The induction field extends theoretically over the

whole of space, but is negligible compared with the radiation field except in the neighbourhood of the [antenna] (IEV 60-32-045).

**induction zone; near zone** The region surrounding a transmitting [antenna] in which there is a significant pulsation of energy to and fro between the [antenna] and the medium. *Note:* The magnetic field strength (multiplied by the impedance of space) and the electric field strength are unequal and, at distances less than one tenth of a wavelength from an [antenna], vary inversely as the square or cube or the distance, if the [antenna] is small compared with this distance (IEV 60-32-055).

**insertion loss** The loss due to the insertion of a transducer between two impedances  $Z_E$  (generator) and  $Z_R$  (load) is the expression in transmission units of the ratio  $P_1/P_2$  where  $P_1$  is the apparent power received by the load  $Z_R$  before the insertion of the said transducer, and  $P_2$  is the apparent power received by the load  $Z_R$  after the insertion of the said transducer (IEV 55-05-160). Unit: decibel (dB).

**irradiation, partial body** Exposure of only part of the body to incident electromagnetic energy.

**irradiation, whole body** Exposure of the entire body to incident electromagnetic energy.

**isotropic** Having the same properties in all directions.

**isotropic radiator** An [antenna] which radiates uniformly in all directions. This is a hypothetical concept used as a standard in connection with the gain function (IEV 60-32-110).

**joule** The work done when the point of application of 1... unit of force [newton] moves a distance of 1 metre in the direction of the force (Comité international des Poids et Mesures, 1946).

**magnetic field strength** An axial vector quantity which, together with magnetic induction, specifies a magnetic field at any point in space. It can be detected by a small magnetised needle, freely suspended, which sets itself in the direction of the field. The free suspension of the magnetised needle assumes, however, that the medium is fluid or that a small gap is provided of such a shape and in such a direction that free movement is possible. As long as the induction is solenoidal, the magnetic field is irrotational outside the spaces in which the current density is not zero, so that it derives a potential (non-uniform) therefrom.

On the other hand, in the interior of currents, its curl, in the rationalised system, is equal to the vector current density, including the displacement current.

The direction of the field is represented at every point by the axis of a small elongated solenoid, its intensity and direction being such that it counterbalances all magnetic effects in its interior, whilst the field intensity is equal to the linear current density of the solenoid (IEV 05-25-020). Symbol:  $H$ . Unit: ampere per metre (A/m).

**magnetic flux** The area integral of the magnetic flux density (IEV 901-01-04). Symbol:  $\Phi$ . Unit: weber (Wb).

**magnetic flux density** A solenoidal axial vector quantity which at any point defines the magnetic field at that point. Its value is such that the force exerted on an electric charge at that point moving at a given velocity is equal to the charge multiplied by the vector product of the velocity and the magnetic flux density (IEV 901-01-03). Symbol:  $B$ . Unit: tesla (T).

**microwaves** Electromagnetic waves of sufficiently short wavelength that practical use can be made of waveguide and associated cavity techniques in their transmission and reception (IEV 60-02-025). (*Note:* for the purposes of the foregoing document the term is taken to

- signify waves having an approximate frequency range of 0.3–300 GHz).
- near zone** See **induction zone**
- peak envelope power** Of a radio transmitter, the average power supplied to the [antenna] transmission line or specified artificial load by a transmitter during one radio frequency cycle at the highest crest of the modulation envelope, taken under conditions of normal operation (IEV 60-42-260).
- peak pulse amplitude** See **pulse amplitude**
- peak pulse output power** The maximum value of output power during a stated time interval, spikes excluded (IEV 531-41-17).
- period** The minimum interval of the independent variable after which the same characteristics of a periodic phenomenon recur (IEV 05-02-40). Symbol:  $T$ . Unit: second (s).
- permeability** The scalar or matrix quantity whose product by the magnetic field strength is the magnetic flux density. *Note:* For isotropic media, the permeability is a scalar; for anisotropic media, a matrix (IEV 121-01-37). Synonym: absolute permeability. If the permeability of a material or medium is divided by the permeability of vacuum (magnetic constant) the result is termed **relative permeability**. Symbol:  $\mu$ . Unit: henry per metre (H/m).
- permittivity; dielectric constant** A constant giving the influence of an isotropic medium on the forces of attraction or repulsion between electrified bodies (IEV 05-15-120). Symbol:  $E$ . Unit: Farad per metre (F/m).
- permittivity, relative** The ratio of the permittivity of a dielectric to that of a vacuum (IEV 05-15-140). Symbol:  $\epsilon_r$ .
- phase** Of a periodic phenomenon, the fraction of a period through which the time has advanced relative to an arbitrary time origin.
- phase change coefficient** The imaginary part of the propagation coefficient. *Note:* This coefficient determines the change of phase of the voltages or currents (IEV 55-05-260). Deprecated synonyms: phase constant, wavelength constant. Symbol:  $\beta$ . Unit: radian per metre (rad/m).
- polarization** A vector quantity representing the state of dielectric polarization of a medium, and defined at each point of the medium by the dipole moment of the volume element surrounding that point, divided by the volume of that element (IEV 05-15-115).
- polarization, plane of** In a linearly polarized wave, the fixed plane parallel to the direction of polarization and the direction of propagation. *Note:* In optics the plane of polarization is normal to the plane defined above (IEV 60-20-010).
- potential, electric** For electrostatic fields, a scalar quantity, the gradient of which, with reversed sign, is equal to the electric field strength (ISO 31/V; also IEV 05-15-050).
- power** 1. Mean power, work (or energy) divided by the time in which this work (or energy) was produced or absorbed. In periodic phenomena, the average power during a period is generally taken. 2. Instantaneous power, the limit of the average power when the interval of time considered becomes infinitely small (IEV 05-04-025). Symbol:  $P$ . Unit: watt (W).
- power flux density; field intensity** In radio wave propagation, the power crossing unit area normal to the direction of wave propagation (IEV 60-20-075). Symbol:  $W$ . Unit: watts per square metre (W/m<sup>2</sup>).
- power gain** The ratio, usually expressed in decibels, of (1) the output power of an [amplifying device] operated under stated conditions to (2) the driving power (IEV 531-17-26). Symbol:  $G$ .

- power gain of an [antenna]** (in a given direction) The ratio, usually expressed in decibels, of the power that would have to be supplied to a reference [antenna] to the power supplied to the [antenna] being considered, so that they produce the same field strength at the same distance in the same direction; unless otherwise specified, the gain is for the direction of maximum radiation; in each case the reference [antenna] and its direction of radiation must be specified, for example: half-wave loss-free dipole (the specified direction being in the equatorial plane), an isotropic radiator in space (IEV 60-32-115). Symbol: *G*. Unit: decibel (dB).
- Poynting vector** A vector, the flux of which through any surface represents the instantaneous electromagnetic power transmitted through this surface (IEV 05-03-85). Synonym: power flux density.
- propagation constant** A complex constant characterizing the attenuation and phase change per unit of length of the current or voltages which are propagated along a uniform line supposed to be infinitely long (IEV 05-03-150). Symbol: *α*.
- pulse amplitude** The peak value of a pulse (IEV 55-35-100).
- pulse duration** The interval of time between the first and last instant at which the instantaneous value of a pulse (or of its envelope if a carrier frequency pulse is concerned) reaches a specified fraction of the peak amplitude (IEV 55-35-105).
- pulse output power** The ratio of (1) the average output power to (2) the pulse duty factor (IEV 531-41-14).
- pulse repetition rate** The average number of pulses in unit time during a specified period (IEV 55-35-125).
- Q** A measure of the efficiency of a reactive circuit (especially an oscillating circuit) or a component thereof. Its precise definition depends on the nature of the circuit; for an oscillating system without lumped *L* or *C* it is equal to  $2\pi$  times the average energy stored in the field divided by the energy dissipated during one half cycle. Synonyms: *Q* factor, quality factor.
- radar** The use of radio waves, reflected or automatically retransmitted, to gain information concerning a distant object. The measurement of range is usually included (IEV 60-72-005).
- radar scan** See **scanning**
- radiant flux (surface) density** Quotient of the radiant flux at an element of the surface containing the point, by the area of that element (IEV 45-05-155). Symbol: *E*. When this quantity relates to radiation incident on a surface, it is termed **irradiance**; when it relates to radiation emitted from a surface, it is termed **radiant exitance** Symbol: *M* (deprecated synonym: radiant emittance) (IEV 45-05-160/170). Unit: watts per square metre ( $W/m^2$ ).
- radiation field** That part of the field of an [antenna] which is associated with an outward flow of energy (IEV 60-32-040).
- radiation zone; far zone** The region sufficiently remote from a transmitting [antenna] for the energy in the wave to be considered as outward flowing. *Note:* In free space, the magnetic field strength (multiplied by the impedance of space) and the electric field strength are equal in this region and, beyond the Fresnel region, vary inversely with distance from the [antenna]. The inner boundary of the radiation zone can be taken as one wavelength from the [antenna] if the [antenna] is small compared with this distance (IEV 60-32-050).
- radiant intensity** For a source in a given direction, the radiant power leaving the source, or an element of the source, in an element of solid angle containing the given direction, divided by that element of solid angle (ISO 31/VI). Symbol: *I*. Unit: watt per steradian ( $W/sr$ ).

- With reference to antennas, this quantity is also called **radiated power per unit solid angle in a given direction** (IEV 60-32-090).
- radiation pattern; radiation diagram; directivity pattern** A diagram relating power flux density (or field strength) to direction relative to the [antenna] at a constant large distance from the [antenna]. *Note:* Such diagrams usually refer to planes or the surface of a cone containing the [antenna] and are usually normalized to the maximum value of the power flux density or field strength (IEV 60-32-135).
- radio frequency** Any frequency at which electromagnetic radiation is useful for telecommunication (IEV 55-05-060). (See Annex).
- reactance** Imaginary part of impedance (ISO 31/V). Symbol: X. Unit: ohm ( $\Omega$ ).
- reflected wave** A wave, produced by an incident wave, which returns in the opposite direction to the incident wave after reflection at the point of transition (IEV 25-50-065).
- reflection coefficient; return current coefficient** The complex ratio of reflected signal current to incident signal current at the termination (IEV 55-20-180). Symbol: G.
- refractive index** The ratio of the velocity of electromagnetic radiation *in vacuo* to the phase velocity of electromagnetic radiation of a specified frequency in a medium (ISO 31/VI). Symbol:  $\eta$ .
- scanning** Of a radar [antenna], systematic variation of the beam direction for search or angle tracking (IEV 60-72-095). The term is also applied to periodic motion of a radiocommunication antenna.
- scattering** The process by which the propagation of electromagnetic waves is modified by one or more discontinuities in the medium which have lengths of the order of the wave length (IEV 60-20-120); a process in which a change in direction or energy of an incident particle or incident radiation is caused by a collision with a particle or a system of particles (ISO 921). The extent to which the intensity of radiation is decreased in this manner is measured in terms of the **attenuation coefficient (scattering)**.
- scattering cross section** The cross section for the scattering process (IEV 26-05-650). See **cross section; scattering**.
- shield** A mechanical barrier or enclosure provided for protection (IEV 151-01-18). The term is modified in accordance with the type of protection afforded; e.g., a **magnetic shield** is a shield designed to afford protection against magnetic fields.
- standing wave** A state of vibration in which the oscillatory phenomena at all points are governed by the same time function, with the exception of a numerical factor, varying from one point to another (IEV 05-03-065).
- standing-wave ratio** The ratio of the maximum to the minimum amplitude of the current, voltage or field, measured respectively at an adjacent node and antinode in a line or waveguide carrying a standing wave (IEV 60-32-235). Symbol: (S).
- thermograph** A term applied to a variety of instruments for measuring and recording temperature, especially (1) the heat radiated by the human body and (2) atmospheric temperature. The record produced by such an instrument is termed a **thermogram** and the technique is termed **thermography**. *Note:* None of these terms should be used in the context of thermal analysis, where they are deprecated.
- time constant** On an exponentially varying quantity, time after which the quantity would reach its limit if it maintained its initial rate of variation. If a quantity is a function of time given by  $F(t) = A + Be^{-t/\tau}$  then  $\tau$  is the time constant (ISO 31/II).
- transmission factor** Ratio of the transmitted radiant... flux to the incident flux (IEV 45-20-085).

- transmission loss** Over a given transmission path and for a given frequency, the amount, expressed in decibels, by which the available power at the input to a receiver is less than that available from the output stage of a transmitter (IEV 60-20-100).
- wave** A modification of the physical state of a medium which is propagated as a result of a local disturbance (IEV 05-03-005).
- wave, diffracted** A wave caused by the scattering of an incident wave upon an obstacle (IEV 101-05-15).
- waveguide** A system for the transmission of electromagnetic energy by a wave not of TEM type. It may, for example, consist of a metal tube, a dielectric rod or tube, or a single wire (IEV 62-10-005).
- wave incident** A travelling wave before it reaches a transition point (IEV 25-50-055).
- wavelength** The distance between two successive points of a periodic wave in the direction of propagation, in which the oscillation has the same phase (IEV 05-03-030). Symbol:  $\lambda$ . Unit: metre (m).
- wave, plane** A wave such that the corresponding physical quantities are uniform in any plane perpendicular to a fixed direction (IEV 05-03-010).
- wave, transmitted** A wave (or waves) produced by an incident wave which continue(s) beyond the transition point (IEV 25-50-060).
- wave, transverse** A wave characterised by a vector at right angles to the direction of propagation (IEV 05-03-070).

## ANNEX

The terms and explanations included in this annex are for the purposes of this publication only, and are not necessarily valid for any other purpose.

- athermal effect** An effect in a living organism that occurs predominantly as a result of some phenomenon other than a local or whole body rise in temperature.
- depth of penetration** For a plane-wave electromagnetic field incident on the boundary of a lossy medium, the depth of penetration of the wave is taken to be that depth at which the field strength of the wave has been reduced to  $1/e$  or approximately 37% of its original value.
- exposure, high level** At the Warsaw symposium it was agreed that, in the microwave range, "high-level exposure" covers exposure to power flux densities exceeding  $10 \text{ mW/cm}^2$ . There is no agreement as to the meaning of the term when applied to radiation in the RF range.
- exposure, intermittent** This term refers to alternating periods of exposure and absence of exposure varying from a few seconds to several hours. If exposure lasting a few minutes to a few hours alternates with periods of absence of exposure lasting 18—24 hours (exposure repeated on successive days), "repeated exposure" might be a more appropriate term.
- exposure, long-term** This term indicates exposure during a major part of the lifetime of the animal involved; it may, therefore, vary from a few weeks to many years in duration.
- exposure, low-level** At the Warsaw symposium it was agreed that, in the microwave range, "low-level exposure" covers exposure to power flux densities up to  $1 \text{ mW/cm}^2$ . There is no agreement on the meaning of the term when applied to radiation in the RF range.
- exposure, medium-level** At the Warsaw symposium it was agreed that, in the microwave range, "medium-level exposure" covers exposure to power flux densities of  $1\text{--}10 \text{ mW/cm}^2$ . There is no agreement on the meaning of the term when applied to radiation in the RF range.

**exposure, repeated** This term refers to exposures lasting from a few minutes to a few hours repeated on successive days.

**exposure, short-term** This term covers exposures lasting from a few hours to 24 hours, or exposures for a few hours per day repeated for a few days per week.

**exposure, single** This term usually refers to an uninterrupted short-term exposure.

**non-thermal effect** See **athermal effect**.

**radiofrequency** In the present document, this term is used to designate frequencies ranging from 100 kHz to 300 MHz.

**thermal effect** An effect resulting predominantly from a local or whole body temperature rise in the living organism.



## CORRIGENDUM

### ENVIRONMENTAL HEALTH CRITERIA

No. 14

#### Ultraviolet Radiation

Page 24, Table 1:

For the term *Radiant Energy*, the definition of a joule should read:

1 joule = 1 watt second (not 1 watt per 1 second)

For the Term *Radiant Flux*, the definition should read:  $\frac{dQ_e}{dt}$  (not  $\frac{dQ}{dt}$ )

Page 56, line 23:

Delete 8-methylpsoralen

Insert 8-methoxypsoralen

Page 89, Table 12:

Duration of exposure per day - Delete 3h

Insert 8h

- Delete  $W/m^2$

Insert  $mW/m^2$

Page 89 line 5 from bottom of page - Delete effect  $S_L$  as given in Table 12.

Insert effectiveness  $S_\lambda$  as given in Table 11.

Page 92, line 29:

Delete 0.75 %

Insert 0.75

ALGERIA	Société Nationale d'Édition et de Diffusion, 3 bd Zirout Youcef, ALGIERS
ARGENTINA	Carlos Hirsch SRL, Florida 165, Galerías Güemes, Escritorio 453/465, BUENOS AIRES
AUSTRALIA	<i>Mail Order Sales:</i> Australian Government Publishing Service, P.O. Box 84, CANBERRA A.C.T. 2600; <i>or over the counter from:</i> Australian Government Publishing Service Bookshops at: 70 Alinga Street, CANBERRA CITY A.C.T. 2600; 294 Adelaide Street, BRISBANE, Queensland 4000; 347 Swanston Street, MELBOURNE, VIC 3000; 309 Pitt Street, SYDNEY, N.S.W. 2000; Mt Newman House, 200 St. George's Terrace, PERTH, WA 6000; Industry House, 12 Pirie Street, ADELAIDE, SA 5000; 156-162 Macquarie Street, HOBART, TAS 7000 — Hunter Publications, 58A Gipps Street, COLLINGWOOD, VIC 3066 — R. Hill & Son Ltd., 608 St. Kilda Road, MELBOURNE, VIC 3004; Lawson House, 10-12 Clark Street, CROW'S NEST, NSW 2065 Gerold & Co., Graben 31, 1011 VIENNA 1
AUSTRIA	
BANGLADESH	The WHO Programme Coordinator, G.P.O. Box 250, DACCA 5 — The Association of Voluntary Agencies, P.O. Box 5045, DACCA 5
BELGIUM	Office international de Librairie, 30 avenue Marnix, 1050 BRUSSELS — <i>Subscriptions to World Health only:</i> Jean de Lanno, 202 avenue du Roi, 1060 BRUSSELS
BRAZIL	Biblioteca Regional de Medicina, Caixa Postal 20.381, Vila Clementina, 04023 SÃO PAULO, S.P.
BURMA	<i>see</i> India, WHO Regional Office
CANADA	<i>Single and bulk copies of individual publications should be ordered from:</i> Canadian Health Association, 1335 Carling Avenue, Suite 210, OTTAWA, Ont. K1Z 8N8. <i>Subscriptions: Subscription orders, accompanied by cheque made out to the Royal Bank of Canada, Ottawa, Account World Health Organization, should be sent to the World Health Organization, P.O. Box 1800, Postal Station B, OTTAWA, Ont. K1P 5R5. Correspondence concerning subscriptions should be addressed to the World Health Organization, Distribution and Sales, 1211 GENEVA 27, Switzerland</i>
CHINA	China National Publications Import Corporation, P.O. Box 88, BEIJING (PEKING)
COLOMBIA	Distirribros Ltd., Pio Alfonso Garcia, Carrera 4a, Nos 36-119, CARTAGENA
CYPRUS	Publishers' Distributors Cyprus, 30 Demokratias Ave Ayios Dhometious, P.O. Box 4165, NICOSIA
CZECHOSLOVAKIA	Artia, Ve Smeckach 30, 111 27 PRAGUE 1
DENMARK	Munksgaard Export and Subscription Service, Nørre Søgade 35, 1370 COPENHAGEN K
ECUADOR	Libreria Científica S.A., P.O. Box 362, Luque 223, GUAYAQUIL
EGYPT	Osiris Office for Books and Reviews, 50 Kasr El Nil Street, CAIRO
EL SALVADOR	Libreria Estudiantil, Edificio Comercial B No 3, Avenida Libertad, SAN SALVADOR
FIJI	The WHO Programme Coordinator, P.O. Box 113, SUVA
FINLAND	Akateeminen Kirjakauppa, Keskuskatu 2, 00101 HELSINKI 10
FRANCE	Librairie Arnette, 2 rue Casimir-Delavigne, 75006 PARIS
GERMAN DEMOCRATIC REPUBLIC	Buchhaus Leipzig, Postfach 140, 701 LEIPZIG
GERMANY, FEDERAL REPUBLIC OF	Govi-Verlag GmbH, Ginnheimerstrasse 20, Postfach 5360, 6236 ESCHBORN — W. E. Saarbach, Postfach 101 610, Follerstrasse 2, 5000 COLOGNE 1 — Alex. Horn, Spiegelgasse 9, Postfach 3340, 6200 WIESBADEN
GHANA	Fides Enterprises, P.O. Box 1628, ACCRA
GREECE	G.C. Eleftheroudakis S.A., Librairie internationale, rue Nikis 4, ATHENS (T. 126)
HAITI	Max Bouchereau, Librairie "A la Caravelle", Boite postale 111-B, PORT-AU-PRINCE
HONG KONG	Hong Kong Government Information Services, Beaconsfield House, 6th Floor, Queen's Road, Central, VICTORIA
HUNGARY	Kultura, P.O.B. 149, BUDAPEST 62 — Akadémiai Könyvesbolt, Váci utca 22, BUDAPEST V
ICELAND	Snaebjörn Jonsson & Co., P.O. Box 1131, Hafnarstræti 9, REYKJAVIK
INDIA	WHO Regional Office for South-East Asia, World Health House, Indraprastha Estate, Ring Road, NEW DELHI 110002 — Oxford Book & Stationery Co., Scindia House, NEW DELHI 110001; 17 Park Street, CALCUTTA 700016 ( <i>Sub-agent</i> )
INDONESIA	M/s Kalman Book Service Ltd., Kwitang Raya No. 11, P.O. Box 3105/Jkt, JAKARTA
IRAN	Iranian Amalgamated Distribution Agency, 151 Khiaban Soraya, TEHRAN
IRAQ	Ministry of Information, National House for Publishing, Distributing and Advertising, BAGHDAD
IRELAND	The Stationery Office, DUBLIN 4
ISRAEL	Heiliger & Co., 3 Nathan Strauss Street, JERUSALEM
ITALY	Edizioni Minerva Medica, Corso Bramante 83-85, 10126 TURIN; Via Lamarmora 3, 20100 MILAN
JAPAN	Maruzen Co. Ltd., P.O. Box 5050, TOKYO International, 100-31
KOREA REPUBLIC OF	The WHO Programme Coordinator, Central P.O. Box 540, SEOUL
KUWAIT	The Kuwait Bookshops Co. Ltd., Thunayan Al-Ghanem Bldg, P.O. Box 2942, KUWAIT
LAO PEOPLES DEMOCRATIC REPUBLIC	The WHO Programme Coordinator, P.O. Box 343, VIENTIANE
LEBANON	The Levant Distributors Co. S.A.R.L., Box 1181, Makdassi Street, Hanna Bldg, BEIRUT

LUXEMBOURG	Librairie du Centre, 49 bd Royal, LUXEMBOURG
MALAWI	Malawi Book Service, P.O. Box 30044, Chichiri, BRANTYRE 3
MALAYSIA	The WHO Programme Coordinator, Room 1004, Fitzpatrick Building, Jalan Raja Chulan, KUALA LUMPUR 05-02 — Jubilee (Book) Store Ltd, 97 Jalan Tanjau Abdul Rahman, P.O. Box 629, KUALA LUMPUR 01-08 — Parry's Book Center, K. L. Hilton Hotel, Jln. Treacher, P.O. Box 960, KUALA LUMPUR
MEXICO	La Prensa Médica Mexicana, Ediciones Científicas, Paseo de las Facultades 26, Apr. Postal 20-413, MEXICO CITY 20, D.F.
MONGOLIA	see India, WHO Regional Office
MOROCCO	Editions La Porte, 281 avenue Mohammed V, RABAT
MOZAMBIQUE	INLD, Caixa Postal 4030, MAPUTO
NEPAL	see India, WHO Regional Office
NETHERLANDS	Medical Books Europe BV, Noorderwal 38, 7241 BL LOCHEM
NEW ZEALAND	Government Printing Office, Publications Section, Mulgrave Street, Private Bag, WELLINGTON 1; Walter Street, WELLINGTON; World Trade Building, Cubacade, Cuba Street, WELLINGTON; <i>Government Bookshops at:</i> Hannaford Burton Building, Rutland Street, Private Bag, AUCKLAND; 159 Hereford Street, Private Bag, CHRISTCHURCH; Alexandra Street, P.O. Box 857, HAMILTON; Y & G Building, Princes Street, P.O. Box 1104, DUNEDIN — R. Hill & Son Ltd, Ideal House, Chr Gillies Avenue & Eden Street, Newmarket, AUCKLAND 1
NIGERIA	University Bookshop Nigeria Ltd, University of Ibadan, IBADAN
NORWAY	J. G. Tanum A/S, P.O. Box 1177 Sentrum, OSLO 1
PAKISTAN	Mirza Book Agency, 65 Shahrah-E-Quaid-E-Azam, P.O. Box 729, LAHORE 3
PAPUA NEW GUINEA	The WHO Programme Coordinator, P.O. Box 5896, BOROKO
PHILIPPINES	World Health Organization, Regional Office for the Western Pacific, P.O. Box 2932, MANILA — The Modern Book Company Inc., P.O. Box 632, 922 Rizal Avenue, MANILA 2800
POLAND	Skladnica Ksiegarska, ul Mazowiecka 9, 00052 WARSAW (except periodicals) — BKWZ Ruch, ul Wronia 23, 00840 WARSAW (periodicals only)
PORTUGAL	Livraria Rodrigues, 186 Rua do Ouro, LISBON 2
SIERRA LEONE	Njala University College Bookshop (University of Sierra Leone), Private Mail Bag, FREETOWN
SINGAPORE	The WHO Programme Coordinator, 144 Moulmein Road, G.P.O. Box 3457, SINGAPORE 1 — Select Books (Pte) Ltd, 215 Tanglin Shopping Centre, 2/F, 19 Tanglin Road, SINGAPORE 10
SOUTH AFRICA	Van Schaik's Bookstore (Pty) Ltd, P.O. Box 724, 268 Church Street, PRETORIA 0001
SPAIN	Comercial Athenaeum S.A., Consejo de Ciento 130-136, BARCELONA 15; General Moscardó 29, MADRID 20 — Libreria Diaz de Santos, Lagasca 95 y Maldonado 6, MADRID 6; Balmes 417 y 419, BARCELONA 22
SRI LANKA	see India, WHO Regional Office
SWEDEN	Aktiebolaget C.E. Fritzes Kungl. Hovbokhandel, Regeringsgatan 12, 10327 STOCKHOLM
SWITZERLAND	Medizinischer Verlag Hans Huber, Länggass Strasse 76, 3012 BERNE 9
SYRIAN ARAB REPUBLIC	M. Farras Kekhia, P.O. Box No. 5221, ALEPPO
THAILAND	see India, WHO Regional Office
TUNISIA	Société Tunisienne de Diffusion, 5 avenue de Carthage, TUNIS
TURKEY	Haset Kitapevi, 469 Istiklal Caddesi, Beyoglu, ISTANBUL
UNITED KINGDOM	H.M. Stationery Office: 49 High Holborn, LONDON WC1V 6HB; 13a Castle Street, EDINBURGH EH2 3AR; 41 The Hayes, CARDIFF CF1 1JW; 80 Chichester Street, BELFAST BT1 4JY; Brazennose Street, MANCHESTER M60 8AS; 258 Broad Street, BIRMINGHAM B1 2HE; Southey House, Wine Street, BRISTOL BS1 2BQ. <i>All mail orders should be sent to P.O. Box 569, LONDON SE1 9NH</i>
UNITED STATES OF AMERICA	<i>Single and bulk copies of individual publications (not subscriptions):</i> WHO Publications Centre USA, 49 Sheridan Avenue, ALBANY, N.Y. 12210. <i>Subscriptions: Subscription orders, accompanied by check made out to the Chemical Bank, New York, Account World Health Organization, should be sent to the World Health Organization, P.O. Box 5284, Church Street Station, New York, N.Y. 10249; Correspondence concerning subscriptions should be addressed to the World Health Organization, Distribution and Sales, 1211 GENEVA 27, Switzerland. Publications are also available from the United Nations Bookshop, NEW YORK, N.Y. 10017 (retail only)</i>
USSR	<i>For readers in the USSR requiring Russian editions:</i> Komsomolskiy prospekt 18, Medicinskaja Kniga, MOSCOW — <i>For readers outside the USSR requiring Russian editions:</i> Kuzneckij most 18, Medzunarodnaja Kniga, MOSCOW G-200
VENEZUELA	Editorial Interamericana de Venezuela C.A., Apartado 50.785, CARACAS 105 — Libreria del Este, Apartado 60.337, CARACAS 106 — Libreria Médica Paris, Apartado 60.681, CARACAS 106
YUGOSLAVIA	Jugoslovenska Knjiga, Terazije 27/II, 11000 BELGRADE
ZAIRE	Librairie universitaire, avenue de la Paix N° 167, B.P. 1682, KINSHASA 1

Special terms for developing countries are obtainable on application to the WHO Programme Coordinators or WHO Regional Offices listed above or to the World Health Organization, Distribution and Sales Service, 1211 Geneva 27, Switzerland. Orders from countries where sales agents have not yet been appointed may also be sent to the Geneva address, but must be paid for in pounds sterling, US dollars, or Swiss francs.

Price: Sw. fr. 9 —

Prices are subject to change without notice.